



## 2. Working & mounting conditions

- 2.1 Ambient temperature is  $-5^{\circ}\text{C} \sim +40^{\circ}\text{C}$ , the average temperature during 24 hours couldn't exceed  $+35^{\circ}\text{C}$ .
- 2.2 Altitude:  $\leq 2000\text{m}$ .
- 2.3 Atmosphere condition:  
Relative humidity of the atmosphere couldn't exceed 50% when the highest temperature is  $+40^{\circ}\text{C}$ ; much higher relative humidity is allowable under the condition of lower temperature, for example, when the temperature reaches  $+20^{\circ}\text{C}$ , the relative humidity is up to 90%. As for dews, which contingently appear due to change of temperature, special steps should be taken.
- 2.4 Pollution degree: 3
- 2.5 Overvoltage category: III

## ND16 Indicator Light

### 1. General information

Degree of protection: IP40, IP65, IP20;  
Standard: IEC/EN60947-5-1



## 3. Technical data



Basic parameters

Rated operational voltage $U_e$ (V)		Rated operational current (mA)	Service life (h)	Brightness ( $\text{cd}/\text{m}^2$ )	Basic color
AC	AC/DC				
400	400	Ie $\leq 20$	$\geq 30000$	$\geq 60$	
230	230				
110	110				
-	48				
-	24				
-	12				
-	36				
-	6				



Note: For AC power supply, the limit voltage range is  $0.85U_e \sim 1.1U_e$  between terminals.

#### 4. ND16 series indicator



★ Flat Platform-Lampshape (Resistance type)

ND16-22A/2	Lamp-Voltage	Model	Color
 	LED: AC/DC 6V, 12V, 24V, 36V, 48V, 110V, 230V, 400V	ND16-22A/2 (W)	○
		ND16-22A/2 (G)	●
		ND16-22A/2 (R)	●
		ND16-22A/2 (Y)	●
		ND16-22A/2 (B)	●



★ Flat Platform-Lampshape (Resistance type)

ND16-22AS/2	Lamp-Voltage	Model	Color
 	LED: AC/DC 6V, 12V, 24V, 36V, 48V	ND16-22AS/2 (W)	○
		ND16-22AS/2 (G)	●
		ND16-22AS/2 (R)	●
		ND16-22AS/2 (Y)	●
		ND16-22AS/2 (B)	●

★ Flat Platform-Lampshape (Capacitor type)

ND16-22A/4	Lamp-Voltage	Model	Color
 	LED: AC 110V, 230V, 400V	ND16-22A/4 (W)	○
		ND16-22A/4 (G)	●
		ND16-22A/4 (R)	●
		ND16-22A/4 (Y)	●
		ND16-22A/4 (B)	●
	LED: AC 230VF, 400VF; (to be used in capacitor gear)	ND16-22A/4 (W)-F	○
		ND16-22A/4 (G)-F	●
		ND16-22A/4 (R)-F	●
		ND16-22A/4 (Y)-F	●
		ND16-22A/4 (B)-F	●

★ Flat Platform-Lampshape (Capacitor type)

ND16-22AS/4	Lamp-Voltage	Model	Color
 	LED: AC 110V, 230V, 400V	ND16-22AS/4 (W)	○
		ND16-22AS/4 (G)	●
		ND16-22AS/4 (R)	●
		ND16-22AS/4 (Y)	●
		ND16-22AS/4 (B)	●

Dimensions (mm)

ND16-22A/□

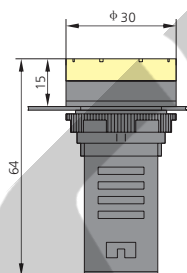



Dimensions (mm)

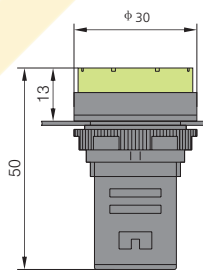

ND16-22AS/□



★ Flat Round Platform-Lampshape (Resistance type)

ND16-22B/2	Lamp-Voltage	Model	Color
 	LED: AC/DC 6V, 12V, 24V, 36V, 48V, 110V, 230V, 400V	ND16-22B/2 (W)	○
		ND16-22B/2 (G)	●
		ND16-22B/2 (R)	●
		ND16-22B/2 (Y)	●
		ND16-22B/2 (B)	●



★ Compacted Flat Round Platform-Lampshape (Resistance type)

ND16-22BS/2	Lamp-Voltage	Model	Color
 	LED: AC/DC 6V, 12V, 24V, 36V, 48V	ND16-22BS/2 (W)	○
		ND16-22BS/2 (G)	●
		ND16-22BS/2 (R)	●
		ND16-22BS/2 (Y)	●
		ND16-22BS/2 (B)	●

Pushbuttons & Indicator Lights & buzzers  
Indicator Lights



★ Flat Round Platform-Lampshade (Capacitance type)

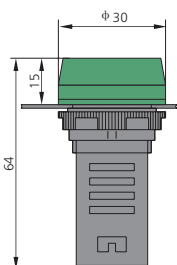

ND16-22B/4	Lamp-Voltage	Model	Color
	LED: AC 110V, 230V, 400V	ND16-22B/4 (W)	○
		ND16-22B/4 (G)	●
		ND16-22B/4 (R)	●
		ND16-22B/4 (Y)	●
		ND16-22B/4 (B)	●
	LED: AC 230VF, 400VF; (to be used in capacitor gear)	ND16-22B/4 (W)-F	○
		ND16-22B/4 (G)-F	●
		ND16-22B/4 (R)-F	●
		ND16-22B/4 (Y)-F	●
		ND16-22B/4 (B)-F	●

Dimensions (mm)



ND16-22B/□

★ Compacted Flat Round Platform-Lampshade (Capacitance type)

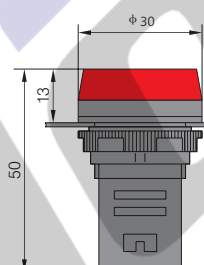

ND16-22BS/4	Lamp-Voltage	Model	Color
	LED: AC 110V, 230V, 400V	ND16-22BS/4 (W)	○
		ND16-22BS/4 (G)	●
		ND16-22BS/4 (R)	●
		ND16-22BS/4 (Y)	●
		ND16-22BS/4 (B)	●
		ND16-22BS/4 (W)-F	○
		ND16-22BS/4 (G)-F	●
		ND16-22BS/4 (R)-F	●
		ND16-22BS/4 (Y)-F	●
		ND16-22BS/4 (B)-F	●

Dimensions (mm)





ND16-22BS/□



★ Arc Surface ripple-Lampshade (Resistance type)

ND16-22C/2	Lamp-Voltage	Model	Color
	LED: AC/DC 6V, 12V, 24V, 36V, 48V, 110V, 230V, 400V	ND16-22C/2 (W)	○
		ND16-22C/2 (G)	●
		ND16-22C/2 (R)	●
		ND16-22C/2 (Y)	●
		ND16-22C/2 (B)	●
		ND16-22C/2 (W)-F	○
		ND16-22C/2 (G)-F	●
		ND16-22C/2 (R)-F	●
		ND16-22C/2 (Y)-F	●
		ND16-22C/2 (B)-F	●



★ Compacted Arc Surface ripple-Lampshade (Resistance type)

ND16-22CS/2	Lamp-Voltage	Model	Color
	LED: AC/DC 6V, 12V, 24V, 48V,	ND16-22CS/2 (W)	○
		ND16-22CS/2 (G)	●
		ND16-22CS/2 (R)	●
		ND16-22CS/2 (Y)	●
		ND16-22CS/2 (B)	●
		ND16-22CS/2 (W)-F	○
		ND16-22CS/2 (G)-F	●
		ND16-22CS/2 (R)-F	●
		ND16-22CS/2 (Y)-F	●
		ND16-22CS/2 (B)-F	●

★ Arc Surface ripple-Lampshade (Capacitance type)

ND16-22C/4	Lamp-Voltage	Model	Color
	LED: AC 110V, 230V, 400V	ND16-22C/4 (W)	○
		ND16-22C/4 (G)	●
		ND16-22C/4 (R)	●
		ND16-22C/4 (Y)	●
		ND16-22C/4 (B)	●
	LED: AC 230VF, 400VF; (to be used in capacitor gear)	ND16-22C/4 (W)-F	○
		ND16-22C/4 (G)-F	●
		ND16-22C/4 (R)-F	●
		ND16-22C/4 (Y)-F	●
		ND16-22C/4 (B)-F	●

★ Compacted Arc Surface ripple-Lampshade (Capacitance type)

ND16-22CS/4	Lamp-Voltage	Model	Color
	LED: AC 110V, 230V, 400V	ND16-22CS/4 (W)	○
		ND16-22CS/4 (G)	●
		ND16-22CS/4 (R)	●
		ND16-22CS/4 (Y)	●
		ND16-22CS/4 (B)	●
		ND16-22CS/4 (W)-F	○
		ND16-22CS/4 (G)-F	●
		ND16-22CS/4 (R)-F	●
		ND16-22CS/4 (Y)-F	●
		ND16-22CS/4 (B)-F	●

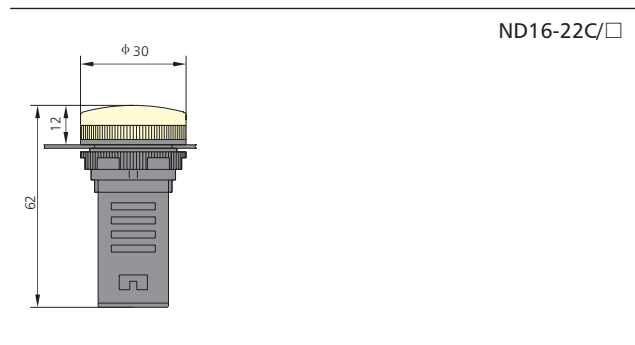

Dimensions (mm)



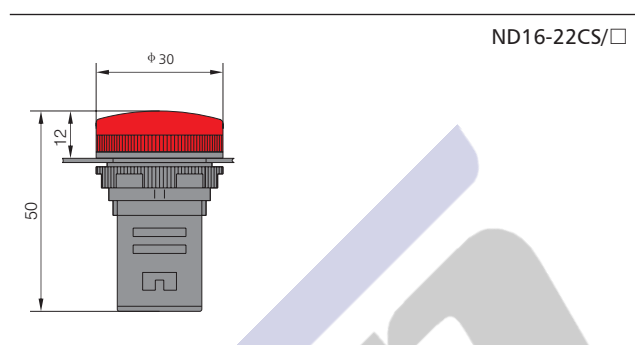

Dimensions (mm)





★ Arc Surface Round-Lampshape (Resistance type)

ND16-22D/2	Lamp-Voltage	Model	Color
 	LED: AC/DC 6V, 12V, 24V, 36V, 48V, 110V, 230V, 400V	ND16-22D/2 (W)	○
		ND16-22D/2 (G)	●
		ND16-22D/2 (R)	●
		ND16-22D/2 (Y)	●
		ND16-22D/2 (B)	●



★ Compacted Arc Surface Round-Lampshape (Resistance type)

ND16-22DS/2	Lamp-Voltage	Model	Color
 	LED: AC/DC 6V, 12V, 24V, 36V, 48V	ND16-22DS/2 (W)	○
		ND16-22DS/2 (G)	●
		ND16-22DS/2 (R)	●
		ND16-22DS/2 (Y)	●
		ND16-22DS/2 (B)	●

★ Arc Surface Round-Lampshape (Capacitance type)

ND16-22D/4	Lamp-Voltage	Model	Color
 	LED: AC 110V, 230V, 400V	ND16-22D/4 (W)	○
		ND16-22D/4 (G)	●
		ND16-22D/4 (R)	●
		ND16-22D/4 (Y)	●
		ND16-22D/4 (B)	●
	LED: AC 230VF, 400VF; (to be used in capacitor gear)	ND16-22D/4 (W)-F	○
		ND16-22D/4 (G)-F	●
		ND16-22D/4 (R)-F	●
		ND16-22D/4 (Y)-F	●
		ND16-22D/4 (B)-F	●

★ Compacted Arc Surface Round-Lampshape (Capacitance type)

ND16-22DS/4	Lamp-Voltage	Model	Color
 	LED: AC 110V, 230V, 400V	ND16-22DS/4 (W)	○
		ND16-22DS/4 (G)	●
		ND16-22DS/4 (R)	●
		ND16-22DS/4 (Y)	●
		ND16-22DS/4 (B)	●

Dimensions (mm)

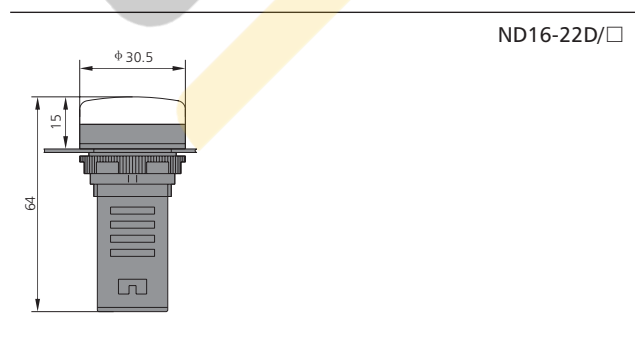

Dimensions (mm)

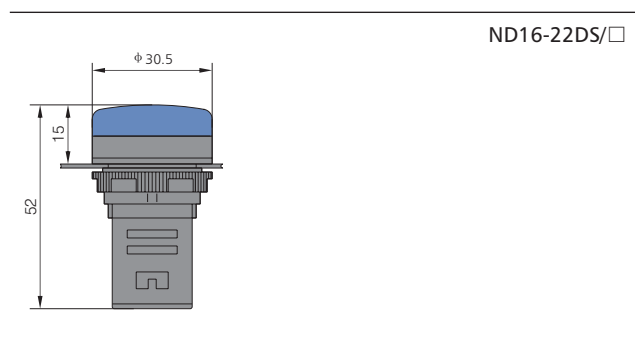

★ Interrupted type

ND16 Buzzer	Model	Color	Voltage
	ND16-22F	●	AC/DC24~ 110V,
		●	AC230V, 400V

★ Interrupted & flush type

ND16 Buzzer	Model	Color	Voltage
	ND16-22FS	●	AC/DC24~ 110V,
		●	AC230V, 400V

★ Continuous type

ND16 Buzzer	Model	Color	Voltage
	ND16-22L	●	AC/DC24~ 110V,
		●	AC230V, 400V

★ Continuous & lit type

ND16 Buzzer	Model	Color	Voltage
	ND16-22LC	●	AC/DC24~ 110V,
		●	AC230V, 400V

Dimension (mm)

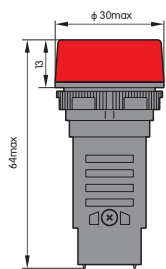

- ND16-22BK/2 AC/DC 24V
- ND16-22BK/2 AC/DC 220V
- ND16-22BK/2 AC/DC 380V
- ND16-22BK/4 AC 220V
- ND16-22BK/4 AC 380V
- ND16-22BK/4 AC 220VF
- ND16-22BK/4 AC 380VF

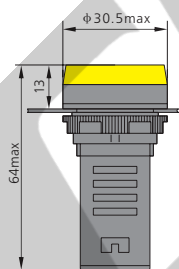

- ND16-22F
- ND16-22FS
- ND16-22L
- ND16-22LC

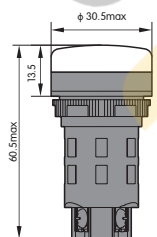

- ND16-22S/2 AC/DC 24V
- ND16-22S/4 AC 220V
- ND16-22S/4 AC 380V
- ND16-22S/4 AC 220VF
- ND16-22S/4 AC 380VF