

# CWB - CONTACTORS

**Compacts** in size.  
**Giants** in technology.

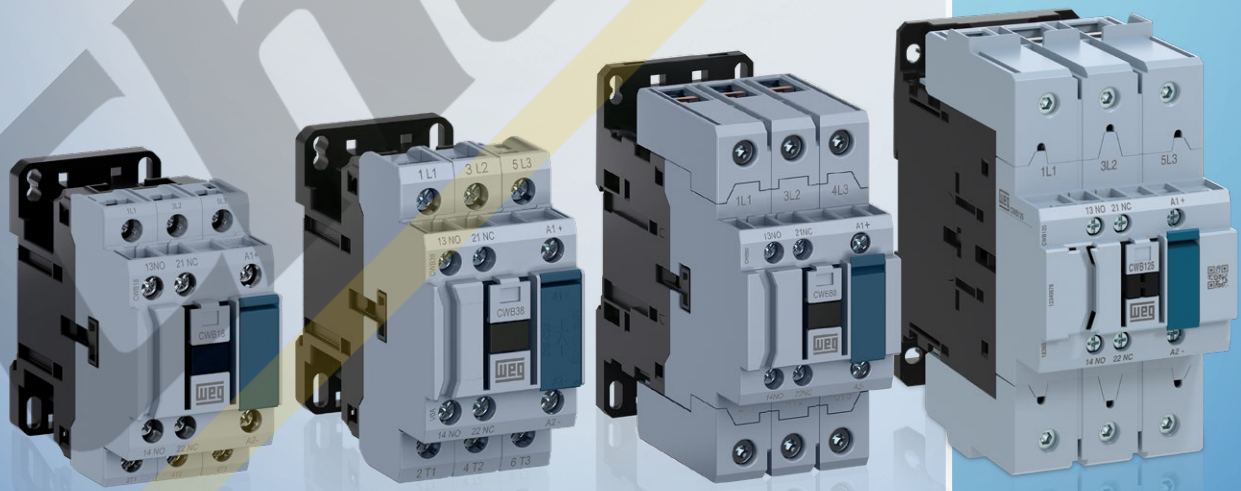

Driving efficiency and sustainability



# S U M M A R Y

<b>Presentation</b>	04
<b>Main characteristics</b>	04
<b>Benefits</b>	05
<b>Certifications</b>	05
<b>Technology within your reach</b>	06
<b>Energy savings</b>	07
<b>Space optimization in electrical panels</b>	08
<b>Flexibility and modularity in assembly of electric panels</b>	10
<b>Construction characteristics</b>	12
<b>Applications</b>	13
<b>Selection table</b>	14
<b>Reliability and safety</b>	15
<b>Accessory overview</b>	16
<b>Accessories</b>	20
<b>Application forms</b>	24
<b>Direct online starter</b>	25
<b>Reversing starters</b>	27
<b>Star-delta starters</b>	29
<b>Contactors for lighting circuits</b>	32
<b>Technical data</b>	35
<b>Dimensions</b>	49



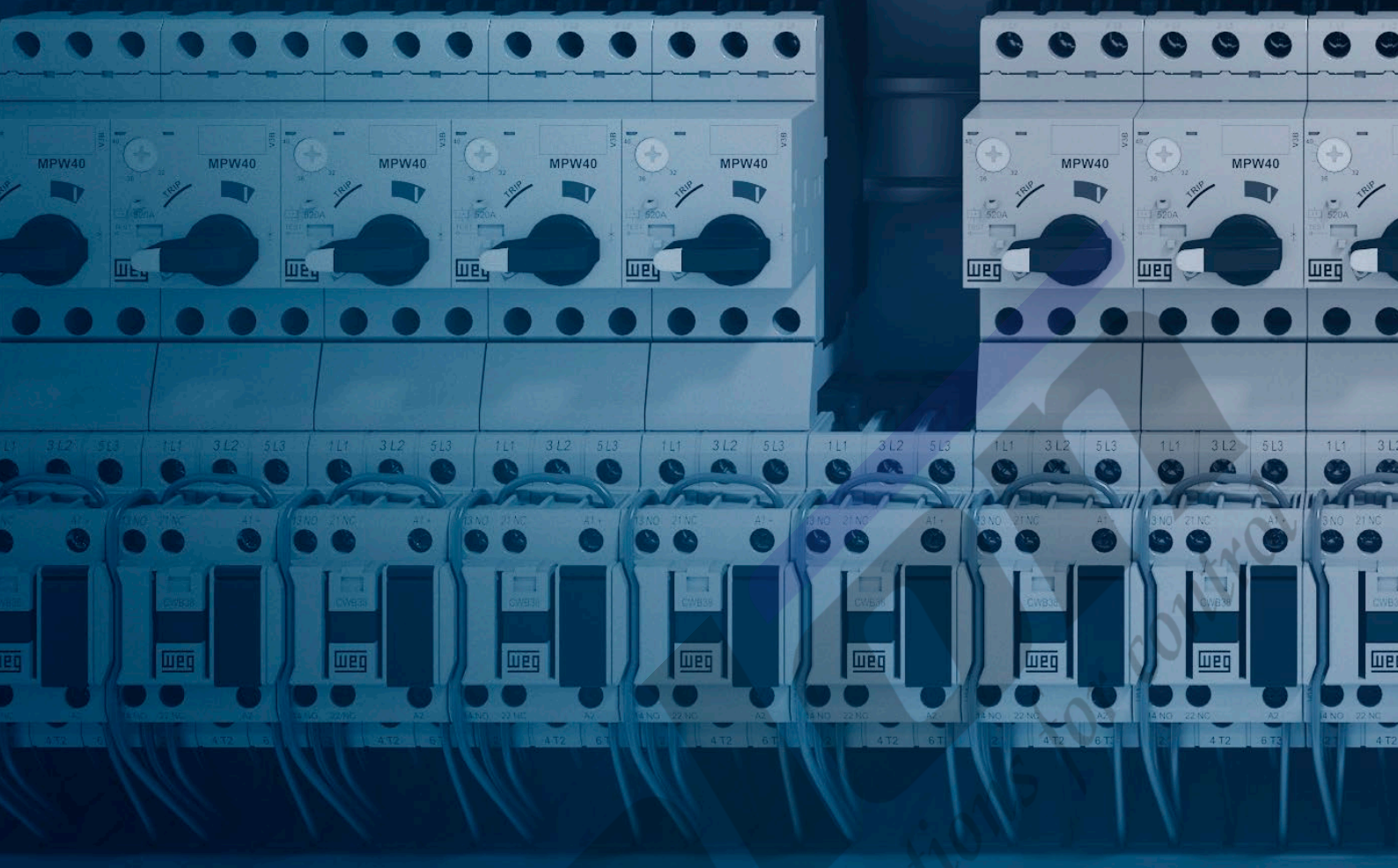

# COMPACTS IN SIZE. GIANTS IN TECHNOLOGY.

Developed according to IEC/EN 60947 and UL 60947 international standards, the CWB and CAWB line of contactors complies with the global requirements of a wide range of industrial applications.

## Main characteristic

- Currents from 9 to 225 A (AC-3)
- Supply voltage from 12 to 600 V
- Low consumption coils
- Compact product
- Built-in auxiliary contacts (1NO and 1NC)
- Four pole versions from 25 to 32 A (AC-1)
- Enclosure for surge suppressors
- Easy identification of the control voltage
- "Zero-width" mechanical interlock
- Easy connection busbars for quick assembly of more compact reversing and star-delta starters
- Compact starters can be assembled with the MPW manual motor protectors and RW overload relays
- Choice of up to six auxiliary contacts on the power contactors
- Compatible with accessories of the whole CWB line
- 45 mm wide auxiliary contactors and five built-in contacts
- Quick mounting on DIN rail 35 mm or with screw

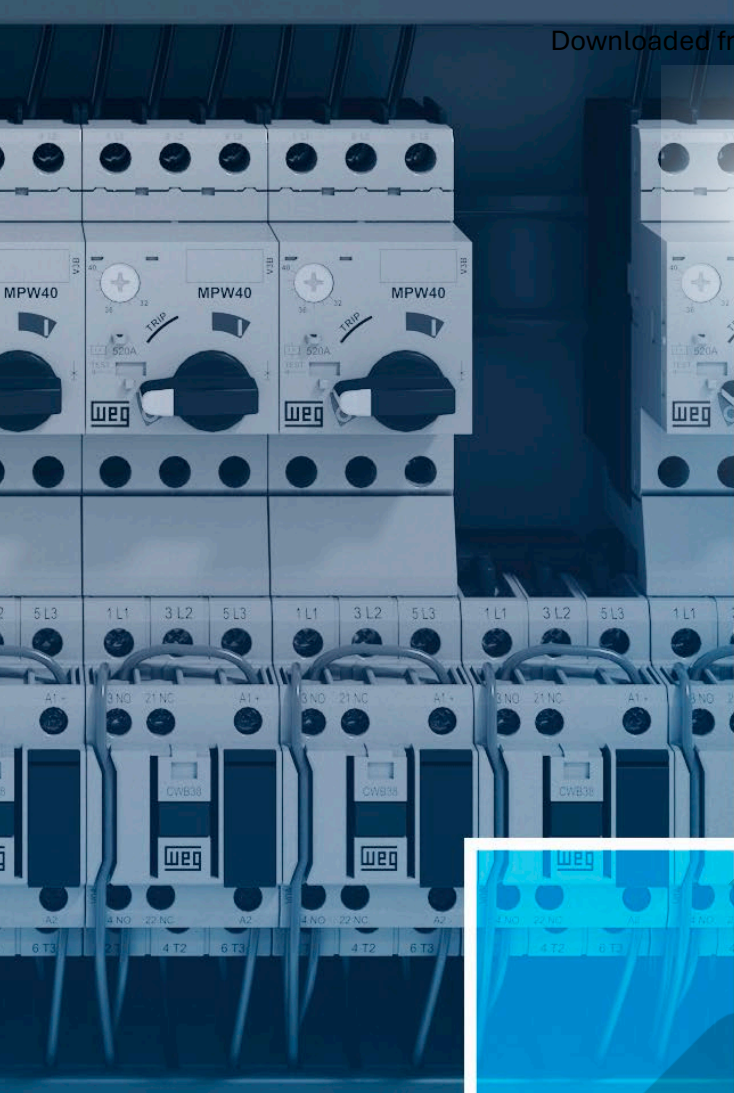

## Benefits



Modular and compact



Highly reliable



Suitable for different applications



Internationally-recognized quality



Simplified installation



Energy saving

## Certifications



European Union



United Kingdom



Canada and USA



Argentina



SABS - South Africa  
South Africa



Colombia



Russia

Note: 1) Please consult the availability of certification with your sales representative.



## Technology within your reach

The use of finite-element analysis and state-of-the-art modeling softwares for simulation of electromagnetic and electromechanical systems provide WEG CWB contactors with an improved project with reduced contact bouncing. The outcome reached by WEG's R&D team ensures a product with long mechanical and electrical lifespan in a reduced size and with lower energy consumption.

The electric contacts of CWB contactors are manufactured with special silver alloys which ensure excellent electric conductivity and high contact reliability. During operation, the double-break contacts and arc chutes ensure fast arc quenching and provide high resistance against the wear effects of the electric arc and, consequently, a long electrical lifespan.

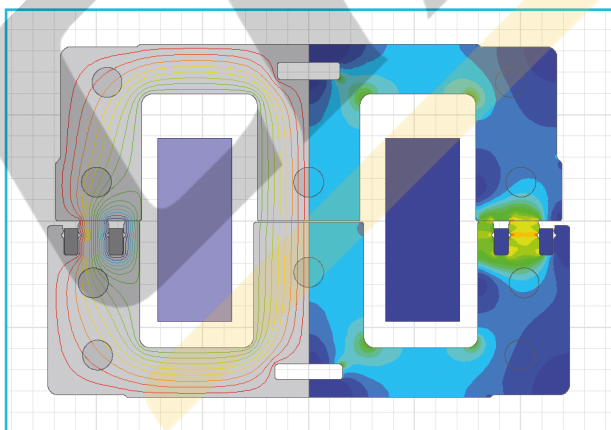

*Analysis of CWB electromagnetic system*

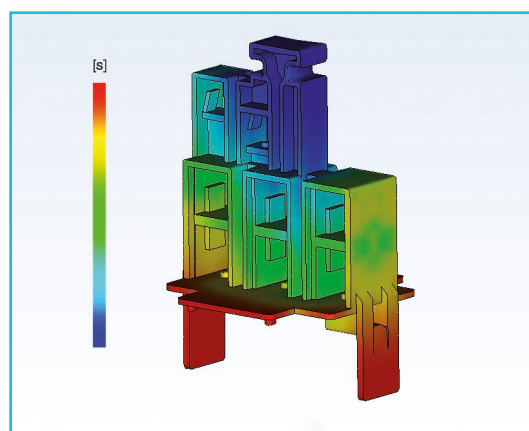

*Process manufacturing simulation to ensure high quality of the injected parts*

Manufactured with the best raw materials and high-quality parts, the CWB line uses high-precision injection molds and metal stamping tools, ensuring very reliable products with the best cost-benefit on the market.

## Energy savings

### Low consumption coils

the low-consumption coils of the CWB contactors enable safe operation with minimum energy consumption of up to 5.8 W in direct current, and up to 7.5 VA in alternating current (for power contactors up to 38 A and auxiliary contactors). In addition to the energy saving, the low consumption of the contactor coils allows using power supplies and transformers with lower rated power. When well dimensioned and properly applied, the traditional electric motor starting methods, such as direct online (reversing and non-reversing) and star-delta starters that use contactors, are the safest and the best cost-benefit options to start and protect low-voltage electric motors. Up to at least 55 kW, direct online starters and star-delta starters that use contactors are still the best and most common starting method in all kinds of industry in the whole world. Even when electronic methods are used to start and control motors, such as frequency inverters and soft-starters, contactors are still necessary in combination with the electronic devices.

Consequently, we can imagine the huge number of contactors installed and in operation, consuming energy in the whole world.

That is why the CWB contactors were designed to operate safe and reliably with the **lowest energy consumption**.

### Coil consumption DC operated contactor

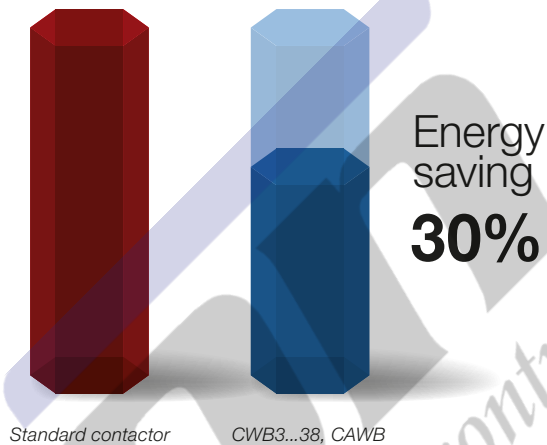

### DC coils and AC/DC electronic coils

The low power consumption characteristics mean that contactors can often be connected directly to the digital outputs of products such as PLCs, frequency inverters, soft-starters and others, without the need for interface relays.



Green



Manufactured with nontoxic and low-impact materials, the CWB line of contactors is safe and sustainable, complying with the RoHS international requirements.

# Space optimization in electrical panels

## Compact solution

As they are compact, 45 mm wide available in up to 38 A (18.5 kW at 380 V AC-3 three-phase), 54 mm wide available from 40 to 80 A (37 kW at 380 V AC-3 three-phase), and 72 mm wide available from 95 to 125 A (55 kW at 380 V AC-3 three-phase), the CWB contactors provide a general reduction in size of electrical panels in comparison to traditional solutions with contactors of the same specification.

Side by side mounting CWB38

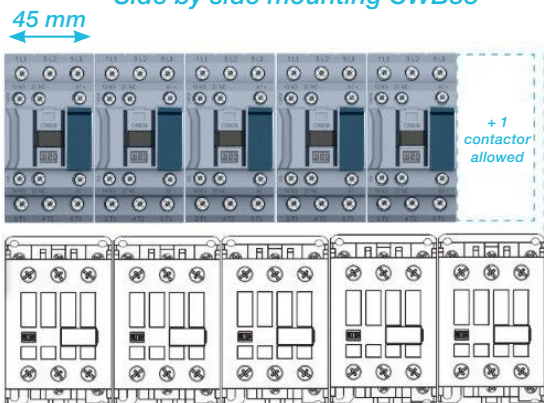

Side by side mounting CWB80

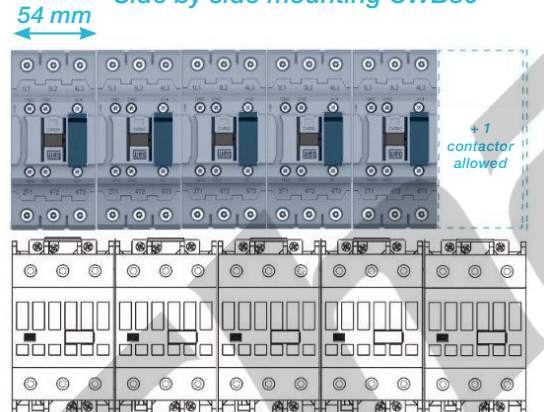

Side by side mounting CWB125

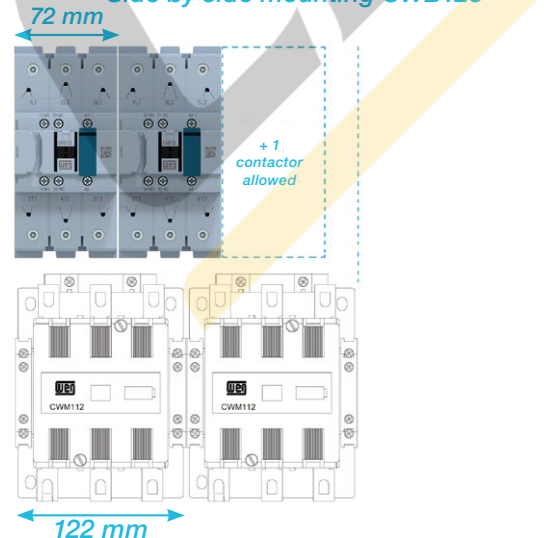

## Built-in auxiliary contacts 1NO + 1NC

The configuration of the two built-in auxiliary contacts (1NO + 1NC) makes the application of the CWB contactors more flexible in most automation systems, contributing to the optimization of the internal space in electrical panels.



## More simple and organized control circuits

In order to optimize the space in electrical panels even more, the CWB line of contactors has a front slot for passing control cables. That can reduce or eliminate the necessity of routing control cables through the side or front part of the contactors, providing a "cleaner" and more organized assembly of the control circuit.

CWB line

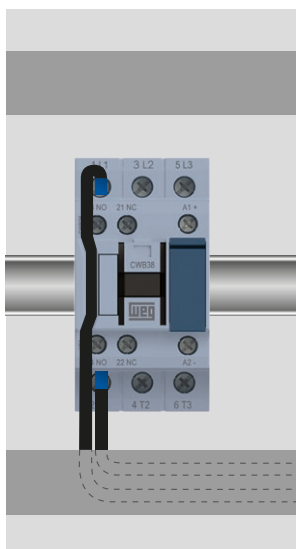

Standard contactors

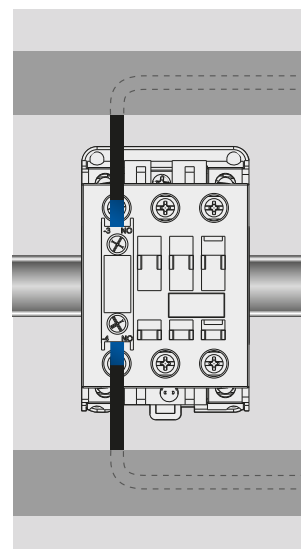



# Space optimization in electrical panels

## Simple and compact mounting of surge suppressor blocks

The coils of CWB contactors operate smoothly with a low level of disturbance in the control circuits. However, in order to reduce voltage surges due to the coil switching even further, WEG has developed surge suppressor blocks especially for the CWB line of contactors, which ensure limitation or even completely eliminate the undesired interferences that may be caused on opening the contactor coil. Surge suppressor blocks are easily mounted on CWB contactors without the need of any kind of tools and also without increasing volume.

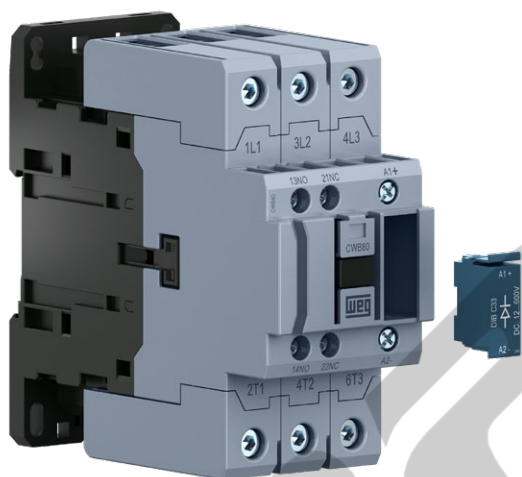

## “Zero-width” mechanical interlock

For applications which require a mechanical interlock between contactors WEG developed a new mechanical system that ensures compact and safe mounting without any tools. The new WEG mechanical interlocking system enables the mechanical interlock between the contactors of the CWB line without adding side space, and it is possible to mount reversing starters of up to 125 A.

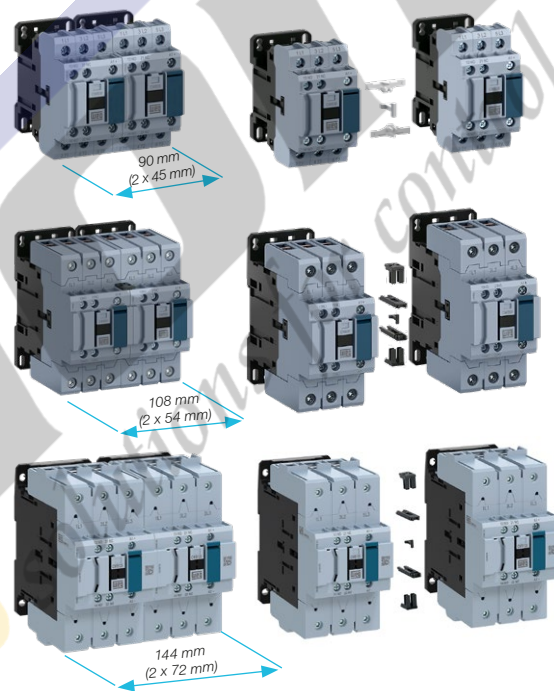

## Contactor coil operated on AC or DC

The CWB line offers coil options for application on the most varied control voltages. The CWB contactors also have characteristics that guarantee easy replacement of the AC coils in currents from 9 to 125 A and DC coils in currents from 40 to 125 A.



CWB9...38 A (AC coil)

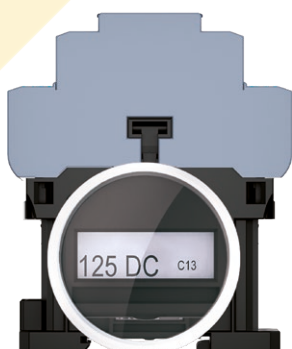

CWB9...38 A (DC coil) CWB40...125 A (all versions)

## Four pole versions

Contactors with four poles from 25 to 32 A (AC-1) with the same width of three pole contactors (45 mm) and with two auxiliary contacts (built-in).





## Flexibility and modularity in assembly of electric panels

### Easy-connection busbars and connectors

The smooth integration between the CWB contactor line, overload relays and manual motor protectors enables simple and quick mounting of compact starters, besides protection sets for low-voltage electric motors with excellent cost effectiveness. The modularity and flexibility of the easy-connection busbars and connectors reduce the mounting time, also preventing possible errors. Available for the whole CWB line, the easy-connection system allows the mounting combined with WEG manual motor protectors and overload relays, forming compact and robust direct starters, reversing and non-reversing starters, in addition to star-delta starters.

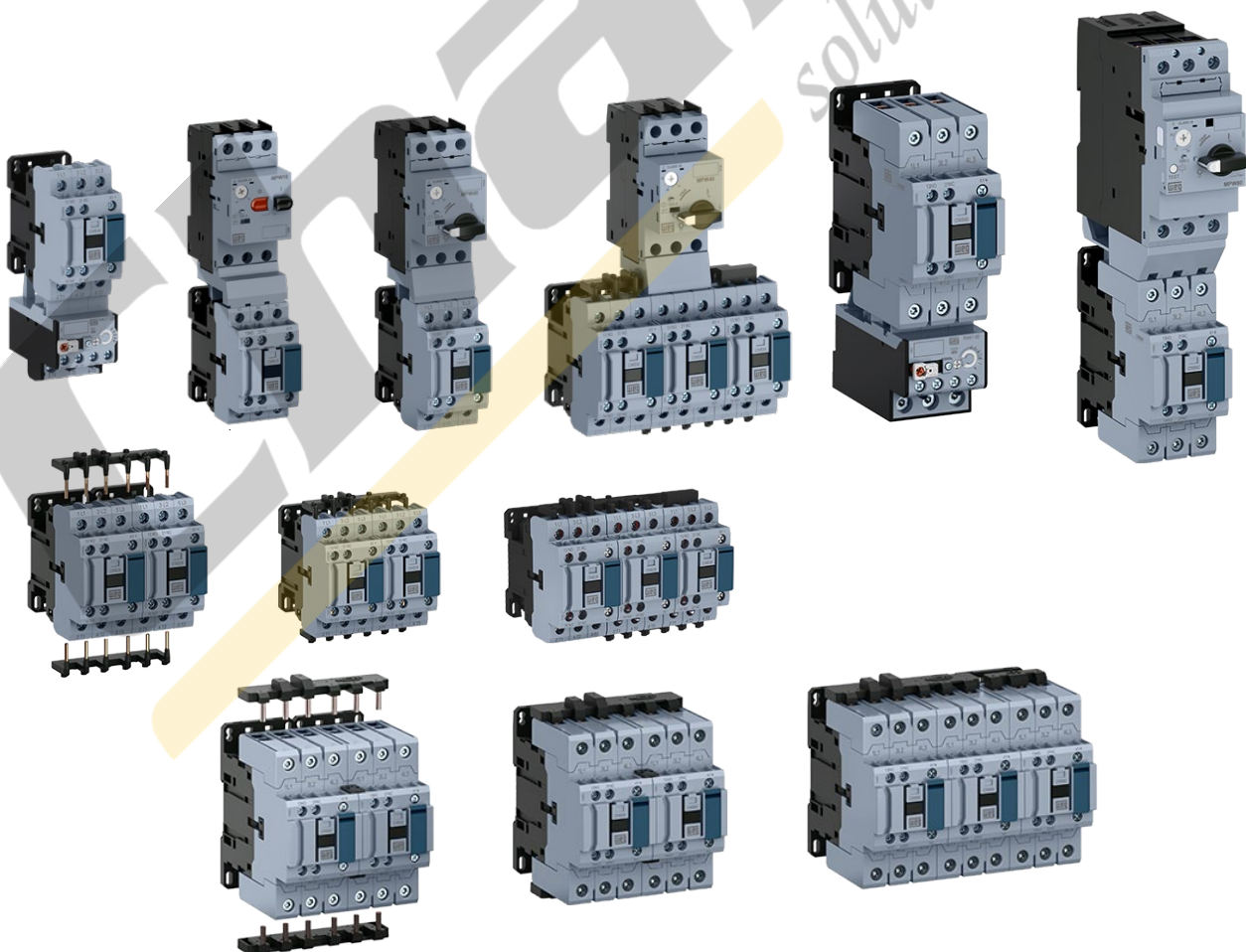

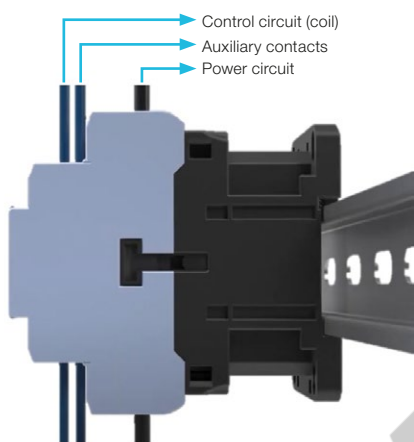
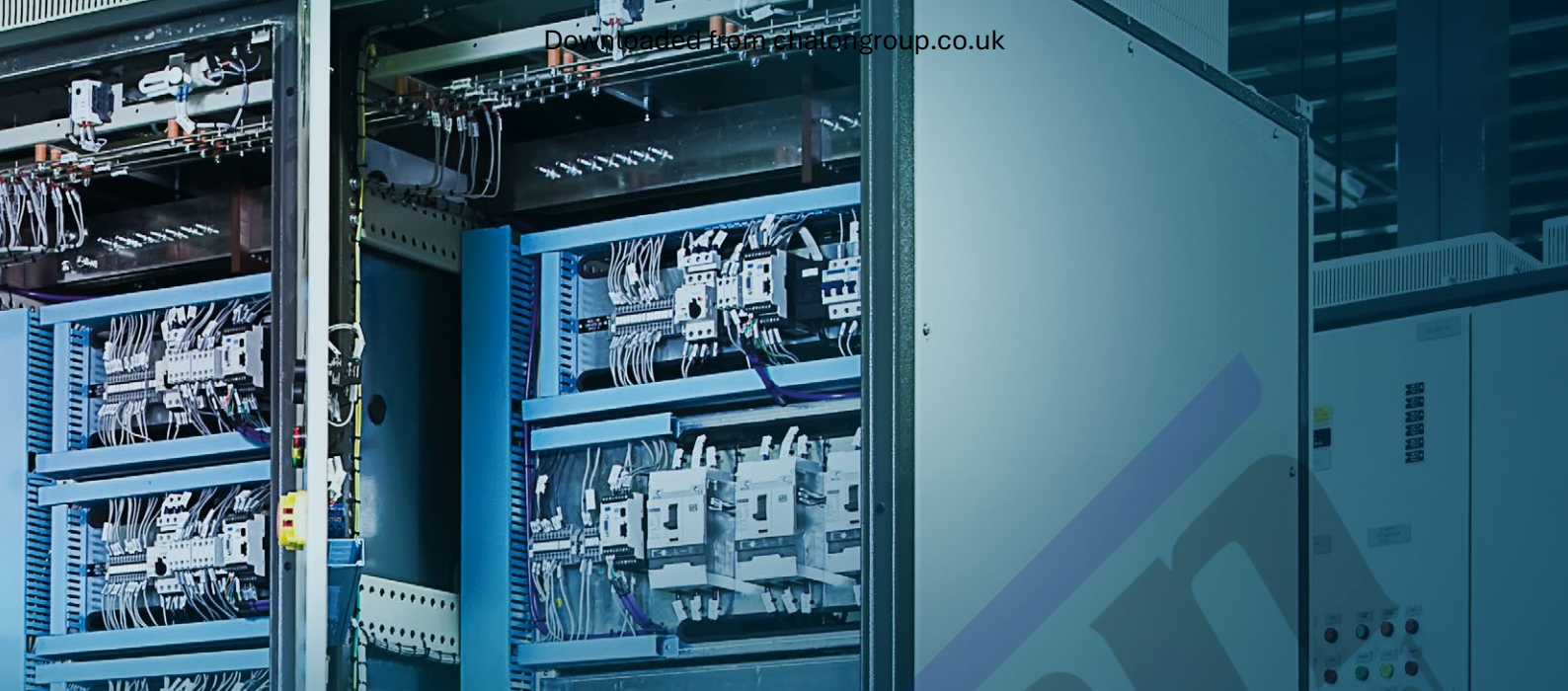

### Easy access power and control terminals

All power terminals, auxiliary contacts and coils provide users with fast front access, facilitating installation, measurements and interventions for preventive and corrective maintenance of starters.

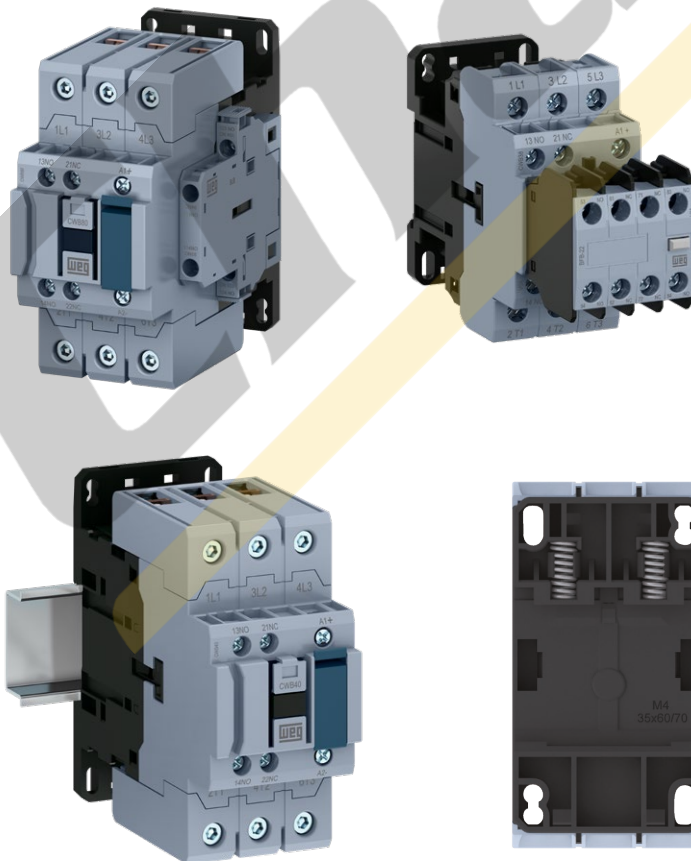

### Additional contact blocks

In addition to the auxiliary contacts already built into the CWB contactors (1NO + 1NC), it is possible to increase their number up to 6 contacts by adding auxiliary contact blocks, available in version for front fitting (BFB) or side fitting (BLB/BLRB). These accessories are compatible with the entire line of 9 A to 125 A CWB power contactors and also with CAWB auxiliary contactors.

### Panel assembly flexibility

CWB contactors can be easily assembled on panels using 35 mm DIN rails or screws because their oblong holes are compatible with the old and traditional lines of contactors on the market.

# Construction characteristics

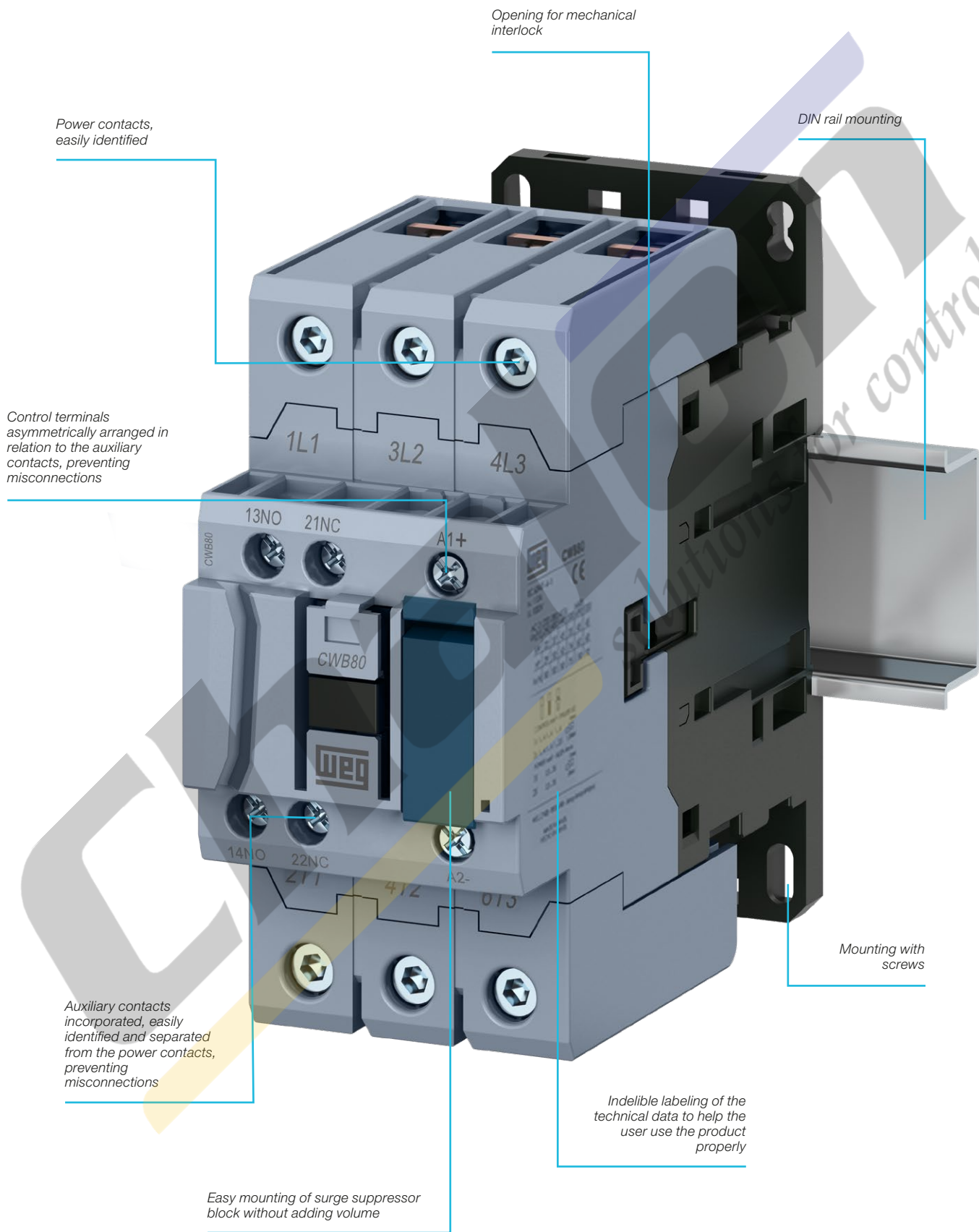

# Applications

The characteristics of the CWB contactors make them suitable for applications in many different segments.



Paper & Cellulose

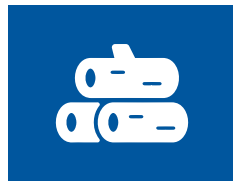

Wood



Cement



Chemical and Petrochemical



Mining



Steel



Oil & Gas



Irrigation and pumping systems



Sugar & Alcohol



Fans



Civil Construction



Refrigeration



Machines and processes in general



Load lifting







Automation







## Selection table

### Three-pole power contactors from 9 A to 225 A (AC-3)

$I_e$ max. ( $U_e \leq 440$ V)	$I_e = I_{th}$ ( $U_e \leq 690$ V) $\theta \leq 55$ °C	Orientative rated operational power in AC-3 <sup>1)</sup> Three-phase motor - IV poles - 60 Hz - 1,800 rpm					Auxiliary contacts per contactor		Reference to fill the control voltage in	Weight <sup>2)</sup> kg
		220 V 230 V	380 V 400 V	415 V 440 V	500 V	660 V 690 V				
AC-3	AC-1									
A	A	kW / cv	kW / cv	kW / cv	kW / cv	kW / cv	NO	NC		
9	25	2.2 / 3	4 / 5.5	4.5 / 6	5.5 / 7.5	5.5 / 7.5	1	1	CWB9-11-30 ♦	0.37
12	25	3 / 4	5.5 / 7.5	6.5 / 8.7	7.5 / 10	7.5 / 10	1	1	CWB12-11-30 ♦	0.37
18	32	4.5 / 6	7.5 / 10	9.2 / 12.5	10 / 13.4	11 / 15	1	1	CWB18-11-30 ♦	0.37
25	40	6.5 / 8.7	12.5 / 16.8	12.5 / 16.8	15 / 20	15 / 20	1	1	CWB25-11-30 ♦	0.41
32	50	7.5 / 10	15 / 20	15 / 20	18.5 / 25	18.5 / 25	1	1	CWB32-11-30 ♦	0.41
38	50	9.2 / 12.5	18.5 / 25	18.5 / 25	18.5 / 25	18.5 / 25	1	1	CWB38-11-30 ♦	0.41
40	60	11 / 15	18.5 / 25	22 / 30	22 / 30	30 / 40	1	1	CWB40-11-30 ♦	0.91
50	90	15 / 20	22 / 30	30 / 40	30 / 40	33 / 44	1	1	CWB50-11-30 ♦	0.91
65	110	18.5 / 25	30 / 40	37 / 50	37 / 50	37 / 50	1	1	CWB65-11-30 ♦	0.91
80	110	22 / 30	37 / 50	45 / 60	55 / 75	45 / 60	1	1	CWB80-11-30 ♦	0.91
95	140	22 / 30	45 / 60	55 / 75	55 / 75	55 / 75	1	1	CWB95-11-30 ♦	1.62
110	150	30 / 40	55 / 75	55 / 75	55 / 75	55 / 75	1	1	CWB110-11-30 ♦	1.62
125	175	37 / 50	55 / 75	75 / 100	75 / 100	75 / 100	1	1	CWB125-11-30 ♦	1.66
150	225	45 / 60	75 / 100	90 / 125	90 / 125	75 / 100	1	1	CWB150-11-30 ♦ <sup>3)</sup>	3.30
180	275	55 / 75	90 / 125	110 / 150	110 / 150	90 / 125	1	1	CWB180-11-30 ♦ <sup>3)</sup>	3.30
225	320	55 / 75	110 / 150	132 / 175	132 / 175	132 / 175	1	1	CWB225-11-30 ♦ <sup>3)</sup>	3.30

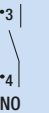
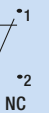
### Four-pole power contactors from 25 A to 32 A (AC-1)

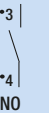
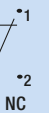
$I_e = I_{th}$ ( $U_e \leq 690$ V) $\theta \leq 55$ °C	Power contacts		Auxiliary contacts		Reference to fill the control voltage in	Weight <sup>2)</sup> kg
						
AC-1						
A	NO	NC	NO	NC		
25	4	0	1	1	CWB9-11-40 ♦	0.38
25	2	2	1	1	CWB9-11-22 ♦	0.38
25	0	4	1	1	CWB9-11-04 ♦ <sup>4)</sup>	0.38
25	4	0	1	1	CWB12-11-40 ♦	0.38
25	2	2	1	1	CWB12-11-22 ♦	0.38
25	0	4	1	1	CWB12-11-04 ♦ <sup>4)</sup>	0.38
32	4	0	1	1	CWB18-11-40 ♦	0.38
32	2	2	1	1	CWB18-11-22 ♦	0.38
32	0	4	1	1	CWB18-11-04 ♦ <sup>4)</sup>	0.38

Replace "♦" by the appropriate coil voltage code.

Notes: 1) Orientative values.

2) Weights for contactors with alternating current control circuit. For direct current control circuit, add 0.110 kg to the CWB9...18 models, 0.120 kg to the CWB25...38 models and 0.060 kg to the CWB5 80 models. For CWB95/110 with electronic coil add 0.010 kg.

CWB150...225 weight for RT version, for TB version add 0.210 kg.



3) Available in RT version (for connecting conductors with ring terminal or busbars) and TB version (for connecting cables with or without ferrules).

4) Available only with AC coils.

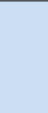

## Selection table

### Auxiliary contactors

I <sub>e</sub> max. (A)		Auxiliary contacts		Reference	Weight (kg)
(U <sub>e</sub> ≤ 230 V) AC-14 / AC-15	(U <sub>e</sub> ≤ 24 V) DC-13	 NO	 NC		
6	4	1	4	CAWB-14-00 ♦	0.372
6	4	2	3	CAWB-23-00 ♦	0.372
6	4	3	2	CAWB-32-00 ♦	0.372
6	4	4	1	CAWB-41-00 ♦	0.372

Replace "♦" by the appropriate coil voltage code.

### Alternating current (CWB9...110 / CAWB)

Code	D02	D07	D13	D23	D24	D25	D33	D34	D35	D36	D39
V (50/60 Hz)	24	48	110	220	230	240	380	400	415	440	480

### Direct current (CWB9...80 / CAWB)

Code	C03	C07	C09	C12	C13	C15
V <sub>dc</sub>	24	48	60	110	125	220

### Alternating current/direct current with electronic module (CWB9...225)

Code	E04	E64	E65	E66
V <sub>ac</sub> (50/60 Hz) and V <sub>dc</sub>	24...60 V	48...130 V	110...255 V	250...500 V

Note: other voltages on request.

## Reliability and safety

### Safety against accidental contact

All the power and control terminals of the CWB contactors have degree of protection that ensure total safety against accidental front contacts.

### Safety-related applications

In automation systems of machines and equipment, it is common to use special contactors in combination with specific safety relays. The CWB line allows such combination due to the arrangement of the contacts, which comply with the requirements of IEC/EN 60947-4-1 Annex F (Mirror Contacts) and IEC/EN 60947-5-1 Annex L (Mechanically Linked Contacts).



IEC/EN 60947-5-1  
Mechanically linked contacts



IEC/EN 60947-4-1  
Mirror contacts

# Accessory overview

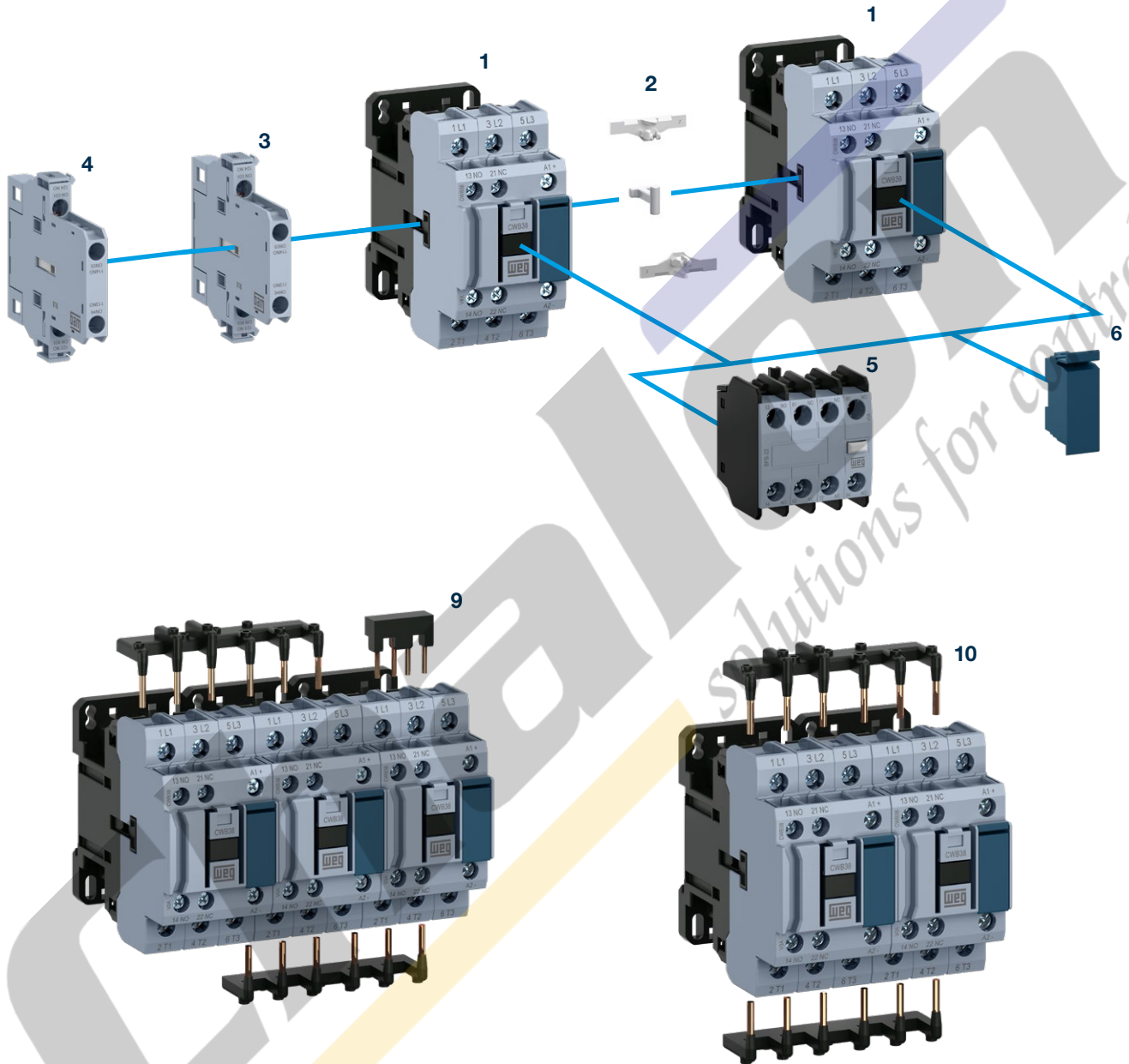

- 1 - CWB9 ... 38 or CAWB contactors
- 2 - "Zero" mechanical interlocking set (IM1)
- 3 - BLB side mounting auxiliary contact block
- 4 - BLRB side mounting auxiliary contact block
- 5 - BFB front auxiliary contact blocks
- 6 - Surge suppressor block



## Accessory overview

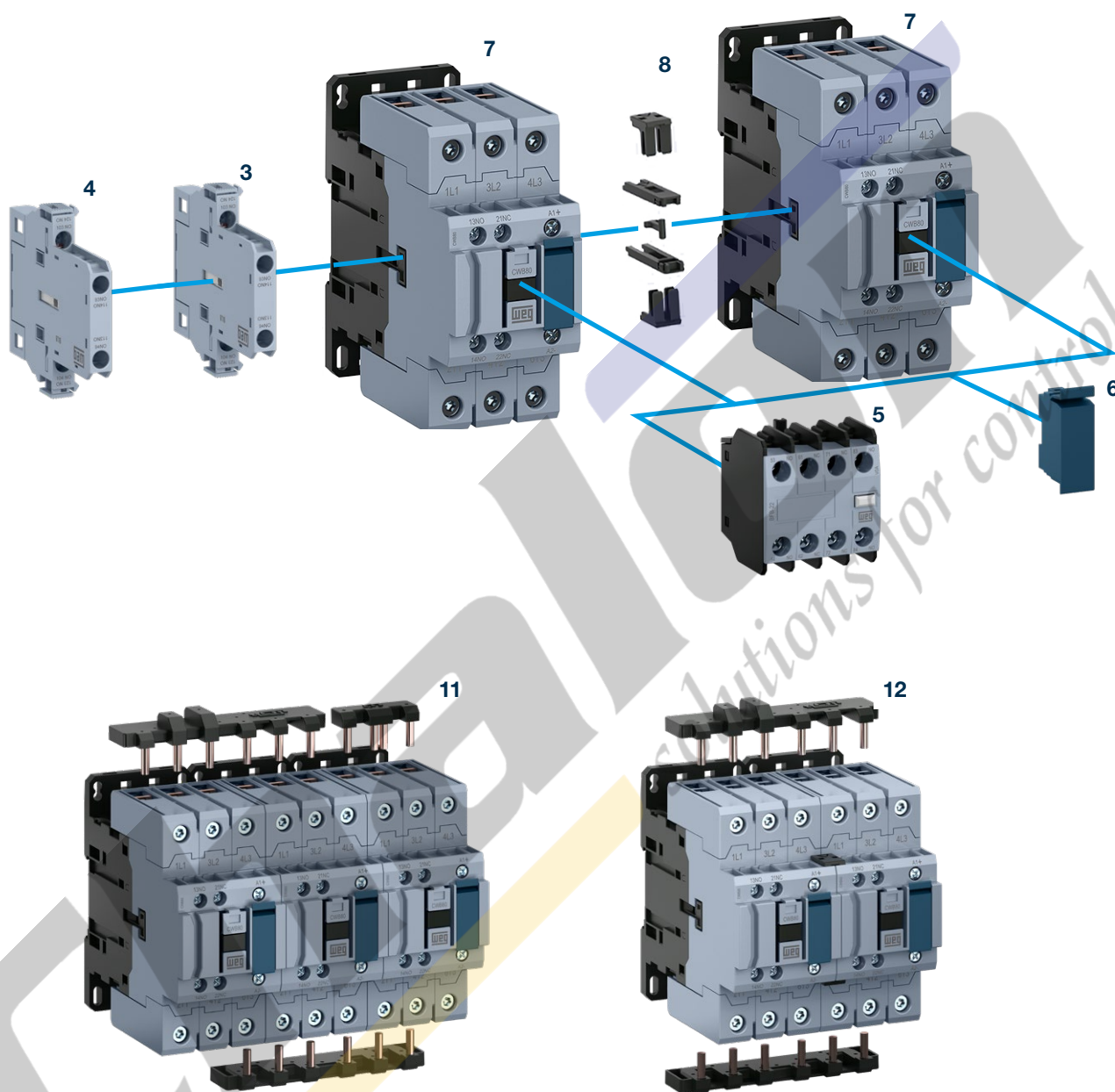

- 7** - CWB40...80 contactors
- 8** - "Zero" mechanical interlocking set (IM2)
- 9** - Busbar for quick connections for star-delta starters (EC-SD1)
- 10** - Busbar for quick connections for reversing starters (EC-R1)
- 11** - Busbar for quick connections for star-delta starters (EC-SD2)
- 12** - Busbar for quick connections for reversing starters (EC-R2)

## Accessory overview

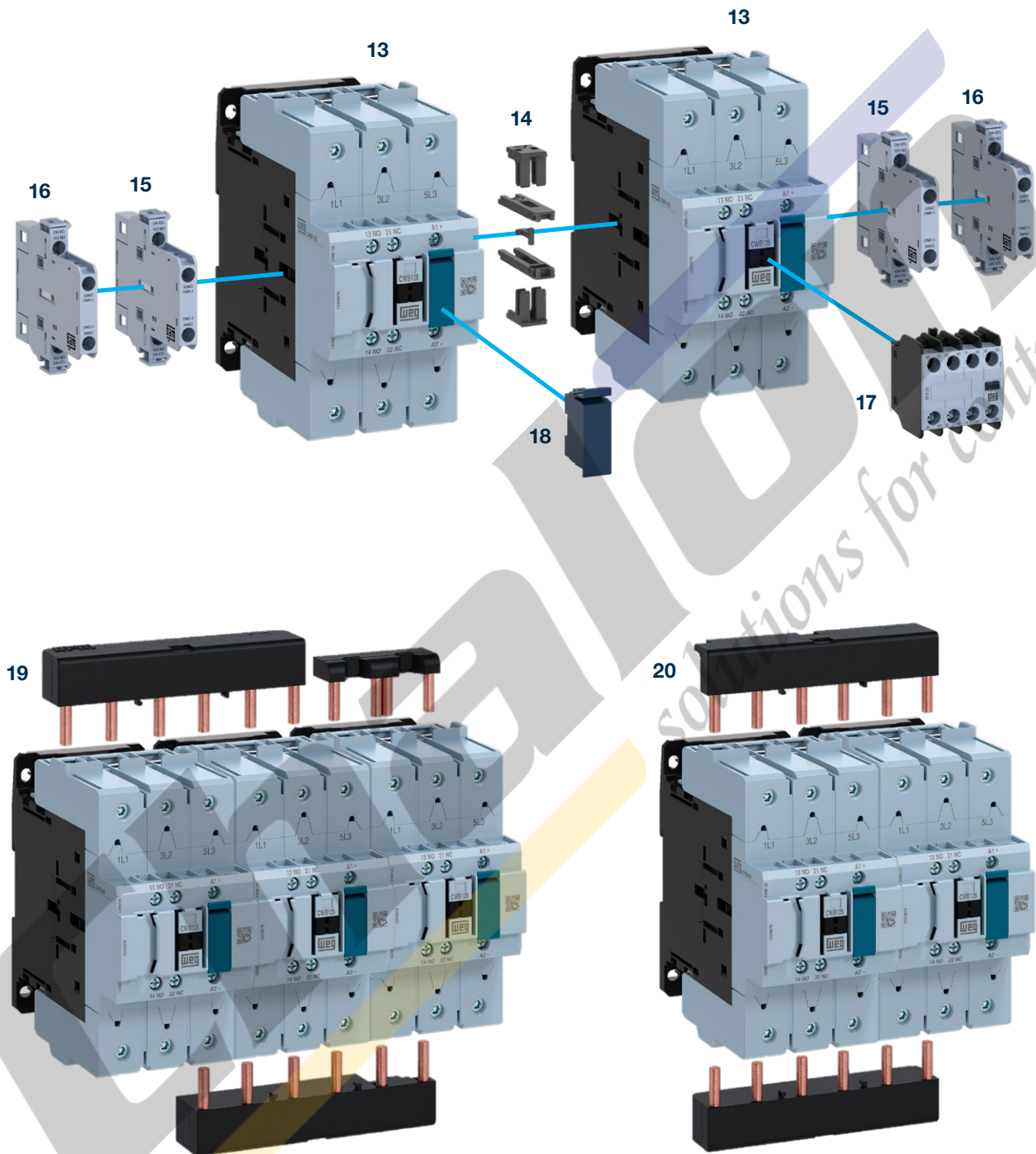

- 13** - CWB95...125 contactors
- 14** - IM2 mechanical interlocking set
- 15** - BLB side mounting auxiliary contact block
- 16** - BLRB side mounting auxiliary contact block
- 17** - BFB front mounting auxiliary contact block
- 18** - Surge suppressor block
- 19** - Busbar for quick connections for star-delta starters (EC-SD3)
- 20** - Busbar for quick connections for reversing starters (EC-R3)

# Accessory overview

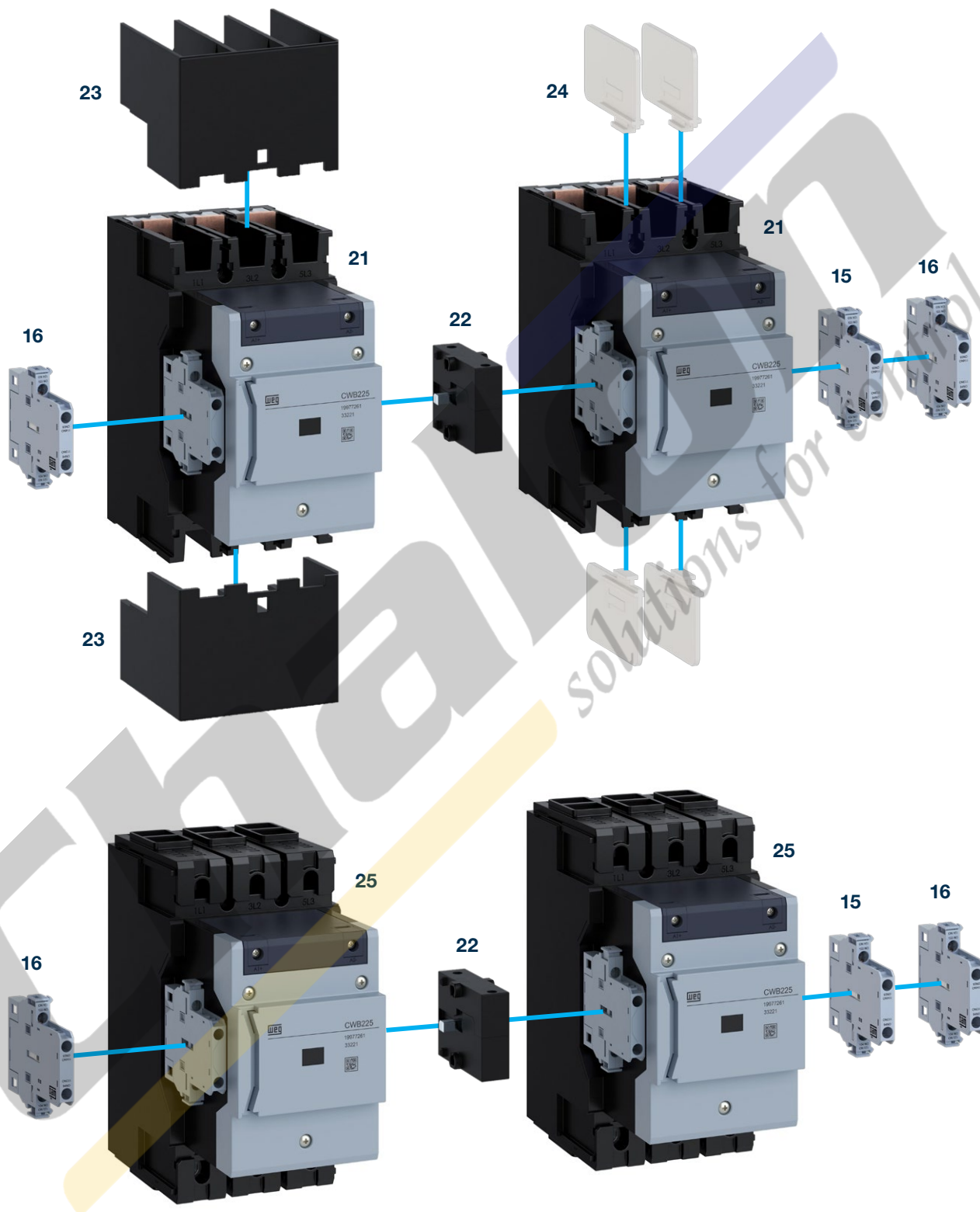

- 21** - CWB150...225\_RT contactors
- 22** - IM3 mechanical interlocking block
- 23** - BMPCWB225 terminal cover
- 24** - Phase barrier CWB150-225
- 25** - CWB150...225\_TB contactors



# Accessories

## Front mounted auxiliary contact blocks

Illustrative picture	For use with	Max. n° of additional contacts / contactor	Auxiliary contacts		Reference	Code	Weight kg	
			NO	NC				
	CWB9...125 CAWB	4 contacts	Auxiliary contact blocks according to IEC/EN 60947					0.063
			1	1	BFB-11 <sup>1)</sup>	12123053		
			2	0	BFB-20	12122434		
			0	2	BFB-02 <sup>1)</sup>	12122946		
			2	2	BFB-22 <sup>1)</sup>	12123051		
			2 <sup>2)</sup>	2 <sup>2)</sup>	BFB-22 EL <sup>2)</sup>	12771537		
			4	0	BFB-40	12122947		
			0	4	BFB-04 <sup>1)</sup>	12123048		
			3	1	BFB-31 <sup>1)</sup>	12123049		
			1	3	BFB-13 <sup>1)</sup>	12123052		
			Auxiliary contact blocks according to EN 50012					0.063
			1	1	BFB-11 EN <sup>1)</sup>	12979242		
			2	0	BFB-20 EN	12979240		
			0	2	BFB-02 EN <sup>1)</sup>	12979241		
			2	2	BFB-22 EN <sup>1)</sup>	12979246		
			4	0	BFB-40 EN	12979243		
			0	4	BFB-04 EN <sup>1)</sup>	12979244		
			3	1	BFB-31 EN <sup>1)</sup>	12979245		
			1	3	BFB-13 EN <sup>1)</sup>	12979247		

## Side mounted auxiliary contact block

Illustrative picture	For use with	Max. n° of additional contacts / contactor	Auxiliary contacts		Reference	Code	Weight kg
			NO	NC			
	CWB9...125 CAWB	4 contacts <sup>4)</sup>	1	1	BLB-11 <sup>1)</sup>	12187899	0.034
			2	0	BLB-20	12187334	
			0	2	BLB-02 <sup>1)</sup>	12187898	
			1	1	BLRB-11 <sup>1)3)</sup>	12230321	
			2	0	BLRB-20 <sup>3)</sup>	12230319	
			0	2	BLRB-02 <sup>1)3)</sup>	12230320	

## Plug-in surge suppressors

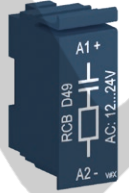
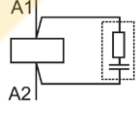
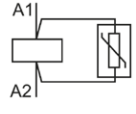
Illustrative picture	For use with	Voltage	Diagram	Reference	Code	Weight kg
	CWB9...110 CAWB	24...48 V 50/60 Hz		RCBD53	12242511	0.008
		50...127 V 50/60 Hz		RCBD55	12242512	
		130...250 V 50/60 Hz		RCBD63	12242513	
		12...48 V 50/60 Hz / 12...60 Vdc		VRBE49	12242514	
		50...127 V 50/60 Hz / 60...180 Vdc		VRBE34	12242515	
		130...250 V 50/60 Hz / 180...300 Vdc		VRBE50	12242516	
		277...380 V 50/60 Hz / 300...510 Vdc		VRBE41	12242517	
		400...510 V 50/60 Hz		VRBD73	12242558	
		12...600 Vdc		DIBC33 <sup>5)</sup>	12242560	
		12...250 Vdc		DIZBC26 <sup>6)</sup>	12242561	

Notes: 1) They comply with the requirements of IEC/EN 60947-4-1 about mirror contacts and the requirements of IEC/EN 60947-5-1 about mechanically linked contacts.  
 2) It contains 1 early-make normally open contact, 1 late-break normally closed contact, 1 normally open contact and 1 normally closed contact.  
 3) For side mounting of two side-auxiliary contact blocks on the same contactor side.  
 4) CWB contactors allow a maximum of 8 auxiliary contacts (4 blocks) as long as there are 2 blocks on each side of the product.  
 5) Contactors assembled with surge suppressor DIB will increase in 6 times the opening time. Do not use in with BFB or BLB auxiliary contact blocks which contain NC contacts.  
 6) Contactors assembled with surge suppressor DIZB will increase in 4 times the opening time.

# Accessories

## Easy-connection setting of the power terminals for reversing starters

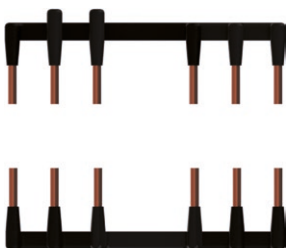
Illustrative picture	For use with		Orientative rated operational power for reversing starters (AC-4 duty) for three-phase 4-pole motors - 60 Hz - 1,800 rpm			Reference	Code	Weight kg
	K1=K2		220 V kW / cv	380 V kW / cv	440 V kW / cv			
	CWB9		1.5 / 2	2.2 / 3	2.2 / 3	EC-R1	12241229	0.042
	CWB12		1.5 / 2	3 / 4	3 / 4			
	CWB18		2.2 / 3	3.7 / 5	3.7 / 5			
	CWB25		3 / 4	5.5 / 7.5	5.5 / 7.5			
	CWB32		3.7 / 5	7.5 / 10.0	7.5 / 10			
	CWB38		3.7 / 5.0	7.5 / 10.0	7.5 / 10			
	CWB40		4.5 / 6.0	9.2 / 12.5	42309	EC-R2	13619637	0.110
	CWB50		5.5 / 7.5	11.0 / 15.0	11.0 / 15.0			
	CWB65		7.5 / 10.0	15.0 / 20.0	15.0 / 20.0			
	CWB80		11.0 / 15.0	18.5 / 25.0	22 / 30			
	CWB95		15 / 20	22 / 30	30 / 40	EC-R3	15299958	0.245
	CWB110		15 / 20	22 / 30	30 / 40			
	CWB125		18.5 / 25	30 / 40	37 / 50			



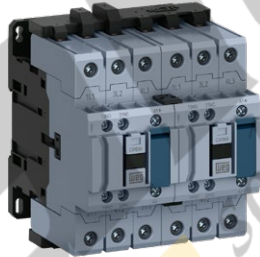
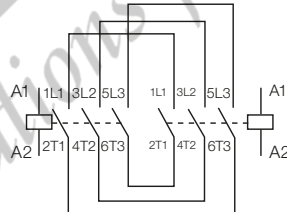

*Electric diagram*

## Power terminal easy-connection set for star-delta starter

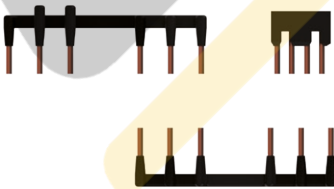
Illustrative picture	For use with		Orientative rated operational power in AC-3 Three-phase motor - IV poles - 60 Hz - 1,800 rpm			Reference	Code	Weight kg
	K1=K2	K3	220 V kW / cv	380 V kW / cv	440 V kW / cv			
	CWB9	CWB9	3.7 / 5	7.5 / 10	7.5 / 10	EC-SD1	12241230	0.048
	CWB12	CWB9	5.5 / 7.5	9.2 / 12.5	11 / 15			
	CWB18	CWB12	7.5 / 10	15 / 20	15 / 20			
	CWB25	CWB18	11 / 15	22 / 30	22 / 30			
	CWB32	CWB18	15 / 20	22 / 30	30 / 40			
	CWB38	CWB25	18.5 / 25	30 / 40	37 / 50			
	CWB50	CWB40	22 / 30	45 / 60	55 / 75	EC-SD2	13619635	0.155
	CWB65	CWB40	30 / 40	55 / 75	55 / 75			
	CWB80	CWB50	37 / 50	55 / 75	75 / 100			
	CWB95	CWB95	45 / 60	75 / 100	90 / 125	EC-SD3	15300079	0.280
	CWB110	CWB110	55 / 75	90 / 125	110 / 150			
	CWB125	CWB125	55 / 75	110 / 150	132 / 175			

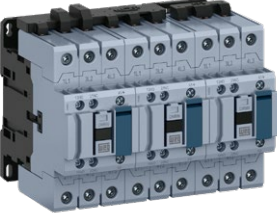
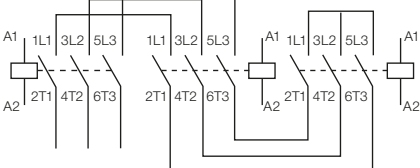

  

*Electric diagram*

## Accessories

### Mechanical interlock

Illustrative picture	For use with	Description	Reference	Code	Weight kg
	CWB9...38 / CAWB	Mounting set for interlocking two contactors with the same frame type. Fitting through snaps without tools.	IM1	12244300	0.01
	CWB40...80 CWB95...125		IM2	13765620	0.01
	CWB150...225		IM3	15977134	0.08

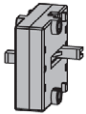
### Insulators and covers

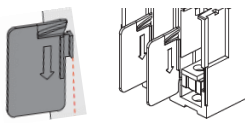
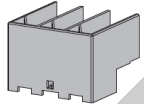
Illustrative picture	For use with	Description	Reference	Code	Weight kg
	CWB150...225	Phase barrier (4 pieces kit)	PHASE BARRIER CWB125-225	17876729	0.18
	CWB150...225	Terminal cover (2 pieces kit)	BMP CWB225	17569506	0.40

## Accessories

## Spare coils for contactors

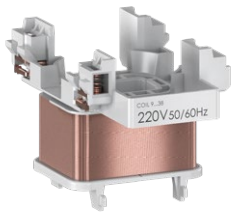
Illustrative picture	For use with	Control type	Reference to fill in with the control voltage	Code	Weight kg
	CWB9...38 / CAWB	AC	BRB-38 ♦	On request	0.08
	CWB40...80	AC	BRB-80 ♦	On request	0.09
		DC	BRB-80 ♦	On request	0.09
		AC/DC <sup>1)</sup>	BRB-80 ♦	On request	0.33
	CWB95/110	AC	BRB-110 ♦	On request	0.15
	CWB95...125	AC/DC <sup>1)</sup>	BRB-125 ♦	On request	0.16
	CWB150...225	AC/DC <sup>2)</sup>	BRB-225 ♦	On request	0.20

Notes: 1) Supply with built-in electronic module.

2) Electronic module supplied separately. Must always be used in conjunction with an electronic module with the same voltage code.

## Spare electronic modules

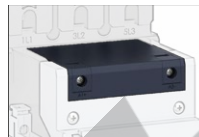
Illustrative picture	For use with	Control type	Reference to fill in with the control voltage	Code	Weight kg
	CWB150...225	AC/DC <sup>1)</sup>	ME-225 ♦	On request	0.08

Note: 1) The electronic module voltage code always must be the same of the contactor coil voltage code.

Replace "♦" by the appropriate coil voltage code.

## Alternating current (CWB9...110/CAWB)

Code	D02	D07	D13	D23	D24	D25	D33	D34	D35	D36	D39
V (50/60 Hz)	24	48	110	220	230	240	380	400	415	440	480

## Direct current (CWB9...80/CAWB)

Code	C03	C07	C09	C12	C13	C15
V <sub>DC</sub>	24	48	60	110	125	220

## Alternating current/direct current with electronic module (CWB9...225)

Code	E04	E64	E65	E66
V <sub>AC</sub> (50/60 Hz) and V <sub>DC</sub>	24...60 V	48...130 V	110...255 V	250...500 V

## Application forms

### Motor starters

With the CWB contactors, the MPW manual motor protectors and the RW overload relays, WEG offers a complete line of compact starters that stand out on the market.

### Easy installation

- Contactors, overload relays and manual motor protectors with a compact design
- Easy-connection bars for direct on-line, reversing and star-delta starters, saving mounting time
- Easy combination of all the starter parts
- Contactors with built-in auxiliary contacts 1NO + 1NC

### Panel optimization

- 9 mm wide side contact blocks
- Compact starters
- "Zero" mechanical interlock without adding side space
- Simple and reliable parts

### Easy operation

- High performance and reliability for a wide range of applications
- Energy savings
- Without peak currents for contactors with DC coil up to 38 A
- Built-in overload and short-circuit protections (when MPW is used)

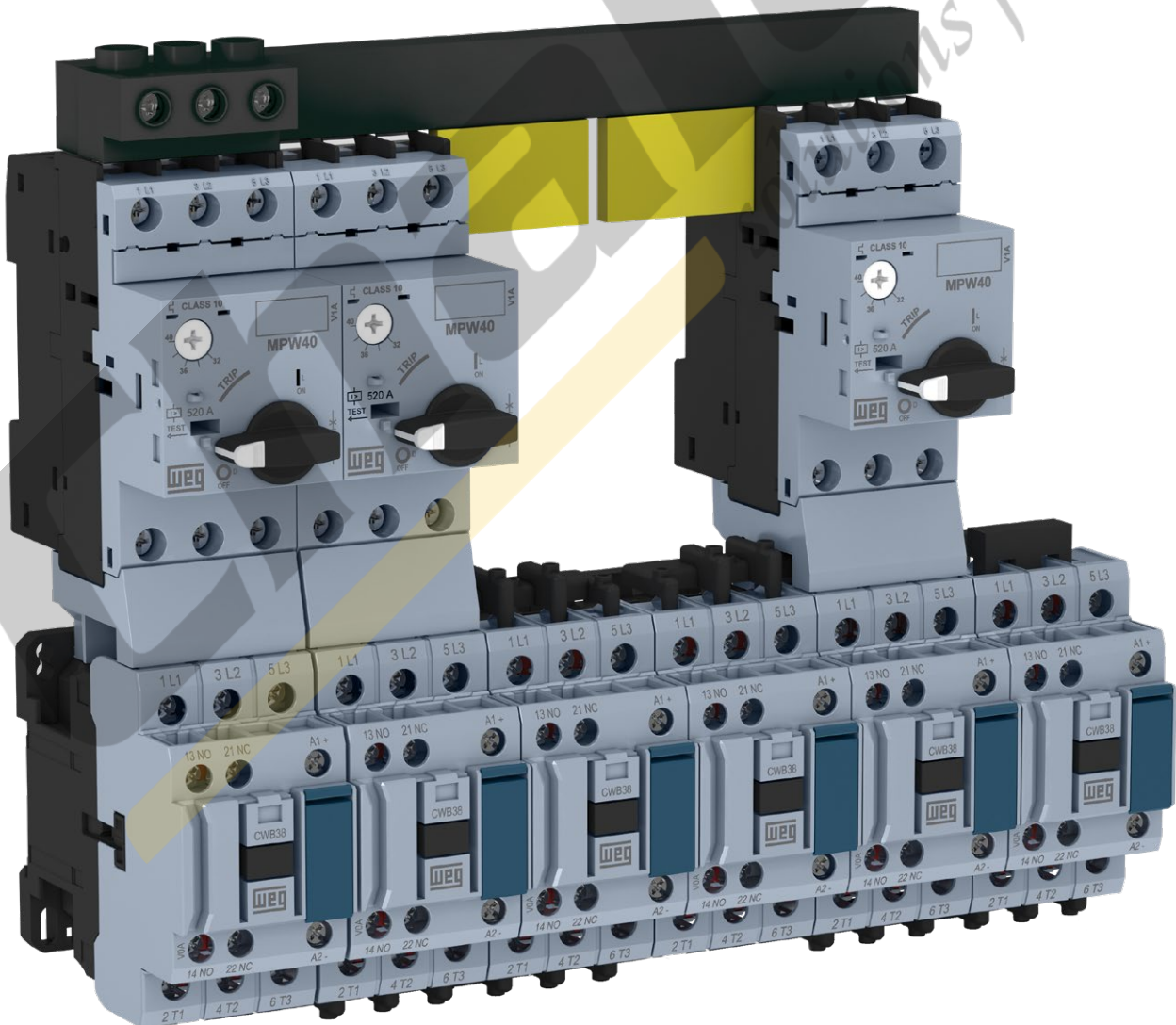



# Direct online starter

## CWB contactor + RW thermal overload relay

- Remote load handling
- Overload protection
- Phase-loss sensitive
- Trip class 10
- Temperature compensation
- DIN rail mounting by fixing only one part
- Manual/local or automatic reset

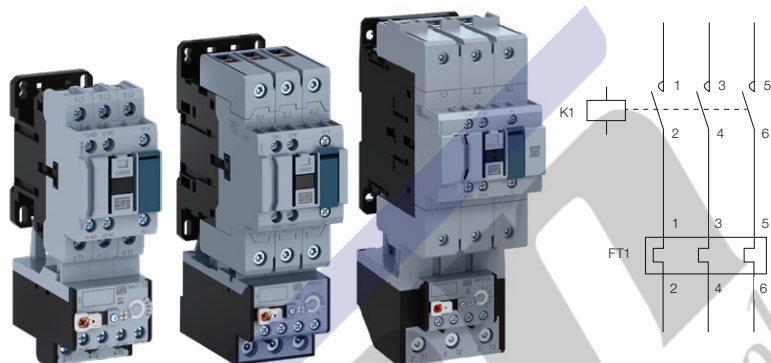

Motor current (A)	AC-3 contact		Overload relay		Fuse
	Reference	Maximum rated current AC-3 (A)	Reference	Current I adjustment range (A)	Maximum fuse (gL/gG) (coordination type 1) (A)
0.28...0.4	CWB9-11-30◆	9	RW27-2D3-D004	0.28...0.4	2
0.43...0.63	CWB9-11-30◆	9	RW27-2D3-C063	0.43...0.63	2
0.56...0.8	CWB9-11-30◆	9	RW27-2D3-D008	0.56...0.8	2
0.8...1.2	CWB9-11-30◆	9	RW27-2D3-D012	0.8...1.2	4
1.2...1.8	CWB9-11-30◆	9	RW27-2D3-D018	1.2...1.8	6
1.8...2.8	CWB9-11-30◆	9	RW27-2D3-D028	1.8...2.8	6
2.8...4	CWB9-11-30◆	9	RW27-2D3-U004	2.8...4	10
4...6.3	CWB9-11-30◆	9	RW27-2D3-D063	4...6.3	16
5.6...8	CWB9-11-30◆	9	RW27-2D3-U008	5.6...8	20
7...9	CWB9-11-30◆	9	RW27-2D3-U010	7...10	25
8...12	CWB12-11-30◆	12	RW27-2D3-D125	8...12.5	25
10...15	CWB18-11-30◆	18	RW27-2D3-U015	10...15	35
11...17	CWB18-11-30◆	18	RW27-2D3-U017	11...17	40
15...23	CWB25-11-30◆	25	RW27-2D3-U023	15...23	50
22...32	CWB32-11-30◆	32	RW27-2D3-U032	22...32	63
32...40	CWB38-11-30◆	38	RW27-2D3-U040	32...40	90
25...40	CWB40-11-30◆	40	RW67-5D3-U040	25...40	80
32...50	CWB50-11-30◆	50	RW67-5D3-U050	32...50	100
40...57	CWB65-11-30◆	65	RW67-5D3-U057	40...57	100
50...63	CWB65-11-30◆	65	RW67-5D3-U063	50...63	100
57...70	CWB80-11-30◆	80	RW67-5D3-U070	57...70	125
63...80	CWB80-11-30◆	80	RW67-5D3-U080	63...80	125
63...80	CWB95-11-30◆	95	RW117-3D3-U080	63...80	200
75...95	CWB95-11-30◆	95	RW117-3D3-U097	75...97	200
90...110	CWB110-11-30◆	110	RW117-3D3-U112	90...112	250
110...125	CWB125-11-30◆	125	RW117-3D3-U140	110...140	315

Notes: Reference values valid for operating voltages up to 440 V, altitude up to 2,000 m, ambient temperature range from -20 °C to +55 °C, and maximum switching frequency up to 15 operations/hour.  
For other conditions, check the technical data of each part.

Replace “◆” by the appropriate coil voltage code.

### Alternating current (CWB9...110/CAWB)

Code	D02	D07	D13	D23	D24	D25	D33	D34	D35	D36	D39
V (50/60 Hz)	24	48	110	220	230	240	380	400	415	440	480

### Direct current (CWB9...80/CAWB)

Code	C03	C07	C09	C12	C13	C15
V <sub>dc</sub>	24	48	60	110	125	220

### Alternating current/direct current with electronic module (CWB9...125)

Code	E04	E64	E65	E66
V <sub>ac</sub> (50/60 Hz) and V <sub>dc</sub>	24...60 V	48...130 V	110...255 V	250...500 V

# Direct online starter

## CWB contactor + MPW manual motor protectors

- Remote load handling
- Overload protection
- Phase-loss sensitive
- Temperature compensation
- DIN rail mounting by fixing only one part
- Manual/local reset
- Isolation and disconnection functions
- Protection against short-circuit
- High short-circuit interrupting capacity
- Short-circuit tripping device fixed at 13 x I<sub>n</sub>

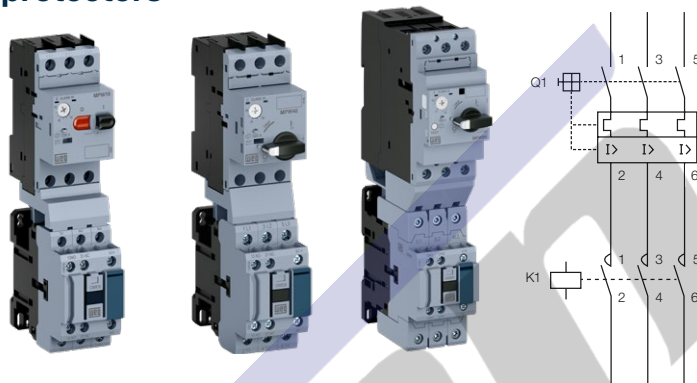

Motor current (A)	AC-3 contactor		Motor-protective circuit breaker			Accessories
	Reference	Maximum rated current AC-3 (A)	Reference	Current I adjustment range (A)	Instantaneous magnetic trip (Im) (A)	Conector
0.1...0.16	CWB9-11-30 ◆	9	MPW18-3-C016	0.1...0.16	2.0	ECCMP-18B38 (CWB - AC Coil)
0.16...0.25	CWB9-11-30 ◆	9	MPW18-3-C025	0.16...0.25	3.2	
0.25...0.4	CWB9-11-30 ◆	9	MPW18-3-D004	0.25...0.4	5.2	
0.4...0.63	CWB9-11-30 ◆	9	MPW18-3-C063	0.4...0.63	8.1	
0.63...1	CWB9-11-30 ◆	9	MPW18-3-U001	0.63...1	13	
1...1.6	CWB9-11-30 ◆	9	MPW18-3-D016	1...1.6	20.8	
1.6...2.5	CWB9-11-30 ◆	9	MPW18-3-D025	1.6...2.5	32.5	
2.5...4	CWB9-11-30 ◆	9	MPW18-3-U004	2.5...4	52	
4...6.3	CWB9-11-30 ◆	9	MPW18-3-D063	4...6.3	81.9	
6.3...10	CWB12-11-30 ◆	12	MPW18-3-U010	6.3...10	130	
10...16	CWB18-11-30 ◆	18	MPW18-3-U016	10...16	208	
16...18	CWB18-11-30 ◆	18	MPW18-3-U020	16...20	260	
0.1...0.16	CWB9-11-30 ◆	9	MPW40-3-C016	0.1...0.16	2	ECCMP-40B38 (CWB - AC Coil) ECCMP-40B38DC (CWB - DC Coil)
0.16...0.25	CWB9-11-30 ◆	9	MPW40-3-C025	0.16...0.25	3.2	
0.25...0.4	CWB9-11-30 ◆	9	MPW40-3-D004	0.25...0.4	5.2	
0.4...0.63	CWB9-11-30 ◆	9	MPW40-3-C063	0.4...0.63	8.1	
0.63...1	CWB9-11-30 ◆	9	MPW40-3-U001	0.63...1	13	
1...1.6	CWB9-11-30 ◆	9	MPW40-3-D016	1...1.6	20.8	
1.6...2.5	CWB9-11-30 ◆	9	MPW40-3-D025	1.6...2.5	32.5	
2.5...4	CWB9-11-30 ◆	9	MPW40-3-U004	2.5...4	52	
4...6.3	CWB9-11-30 ◆	9	MPW40-3-D063	4...6.3	81.9	
6.3...10	CWB12-11-30 ◆	12	MPW40-3-U010	6.3...10	130	
10...16	CWB18-11-30 ◆	18	MPW40-3-U016	10...16	208	
16...20	CWB25-11-30 ◆	25	MPW40-3-U020	16...20	260	
20...25	CWB25-11-30 ◆	25	MPW40-3-U025	20...25	325	
25...32	CWB32-11-30 ◆	32	MPW40-3-U032	25...32	416	
32...38	CWB38-11-30 ◆	38	MPW40-3-U040	32...40	520	
32...40	CWB40-11-30 ◆	40	MPW80-3-U040	32...40	520	
40...50	CWB50-11-30 ◆	50	MPW80-3-U050	40...50	650	ECCMP-80B80 (CWB - AC and DC Coil)
55...65	CWB65-11-30 ◆	65	MPW80-3-U065	55...65	845	
65...80	CWB80-11-30 ◆	80	MPW80-3-U080	65...80	1,040	
55...75	CWB95-11-30 ◆	95	MPW100-3-U075	55...75	975	
70...90	CWB95-11-30 ◆	95	MPW100-3-U090	70...90	1,170	-
80...95	CWB95-11-30 ◆	95	MPW100-3-U100	80...100	1,300	
80...100	CWB110-11-30 ◆	110	MPW100-3-U100	80...100	1,300	

Notes: Reference values valid for operating voltages up to 440 V, altitude up to 2,000 m, ambient temperature range from -20 °C to +55 °C, and maximum switching frequency up to 15 operations/hour.  
For other conditions, check the technical data of each part.

Replace "◆" by the appropriate coil voltage code.

### Alternating current (CWB9...110/CAWB)

Code	D02	D07	D13	D23	D24	D25	D33	D34	D35	D36	D39
V (50/60 Hz)	24	48	110	220	230	240	380	400	415	440	480

### Direct current (CWB9...80/CAWB)

Code	C03	C07	C09	C12	C13	C15
V <sub>dc</sub>	24	48	60	110	125	220

### Alternating current/direct current with electronic module (CWB9...125)

Code	E04	E64	E65	E66
V <sub>AC</sub> (50/60 Hz) and V <sub>dc</sub>	24...60 V	48...130 V	110...255 V	250...500 V

# Reversing starters

## CWB contactors + RW thermal overload relay

- Remote load handling
- Overload protection
- Phase-loss sensitive
- Trip class 10
- Temperature compensation
- DIN rail mounting by fixing the contactors
- Manual/local or automatic reset

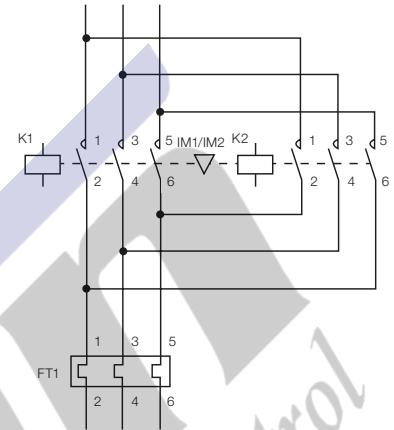
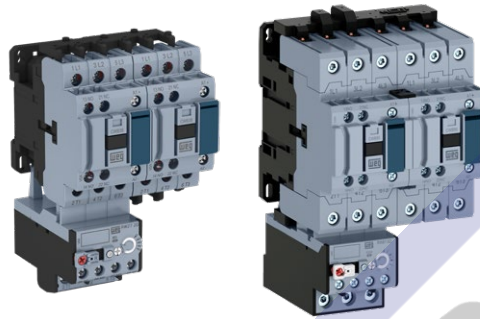

Motor current (A)	AC-3 contactor		Overload relay		Accessories		Fuse
	Reference	Maximum rated current AC-3 (A)	Reference	Current I adjustment range (A)	Mechanical interlock kit	Easy-connection busbar	Maximum fuse (gL/gG) (coordination type 1) (A)
0.28...0.4	CWB9-11-30♦	9	RW27-2D3-D004	0.28...0.4	IM1	EC-R1	2
0.43...0.63	CWB9-11-30♦	9	RW27-2D3-C063	0.43...0.63			2
0.56...0.8	CWB9-11-30♦	9	RW27-2D3-D008	0.56...0.8			2
0.8...1.2	CWB9-11-30♦	9	RW27-2D3-D012	0.8...1.2			4
1.2...1.8	CWB9-11-30♦	9	RW27-2D3-D018	1.2...1.8			6
1.8...2.8	CWB9-11-30♦	9	RW27-2D3-D028	1.8...2.8			6
2.8...4	CWB9-11-30♦	9	RW27-2D3-U004	2.8...4			10
4...6.3	CWB9-11-30♦	9	RW27-2D3-D063	4...6.3			16
5.6...8	CWB9-11-30♦	9	RW27-2D3-U008	5.6...8			20
7...9	CWB12-11-30♦	12	RW27-2D3-U010	7...10			25
8...12	CWB25-11-30♦	25	RW27-2D3-D125	8...12.5			25
10...15	CWB25-11-30♦	25	RW27-2D3-U015	10...15			35
11...17	CWB25-11-30♦	25	RW27-2D3-U017	11...17			40
15...23	CWB25-11-30♦	25	RW27-2D3-U023	15...23			50
22...32	CWB32-11-30♦	32	RW27-2D3-U032	22...32			63
32...38	CWB38-11-30♦	38	RW27-2D3-U040	32...40	90		
25...40	CWB40-11-30♦	40	RW67-5D3-U040	25...40	IM2	EC-R2	80
32...50	CWB50-11-30♦	50	RW67-5D3-U050	32...50			100
40...57	CWB65-11-30♦	65	RW67-5D3-U057	40...57			100
50...63	CWB65-11-30♦	65	RW67-5D3-U063	50...63			100
57...70	CWB80-11-30♦	80	RW67-5D3-U070	57...70			125
63...80	CWB80-11-30♦	80	RW67-5D3-U080	63...80		125	
63...80	CWB95-11-30♦	95	RW117-3D3-U080	63...80		EC-R3	200
75...95	CWB95-11-30♦	95	RW117-3D3-U097	75...97			200
90...110	CWB110-11-30♦	110	RW117-3D3-U112	90...112			250
110...125	CWB125-11-30♦	125	RW117-3D3-U140	110...140			315

Notes: Reference values valid for operating voltages up to 440 V, altitude up to 2,000 m, ambient temperature range from -20 °C to +55 °C, and maximum switching frequency up to 15 operations/hour. For other conditions, check the technical data of each part.

Replace “♦” by the appropriate coil voltage code.

### Alternating current (CWB9...110/CAWB)

Code	D02	D07	D13	D23	D24	D25	D33	D34	D35	D36	D39
V (50/60 Hz)	24	48	110	220	230	240	380	400	415	440	480

### Direct current (CWB9...80/CAWB)

Code	C03	C07	C09	C12	C13	C15
V <sub>dc</sub>	24	48	60	110	125	220

### Alternating current/direct current with electronic module (CWB9...125)

Code	E04	E64	E65	E66
V <sub>ac</sub> (50/60 Hz) and V <sub>dc</sub>	24...60 V	48...130 V	110...255 V	250...500 V

# Reversing starters

## CWB contactor + MPW manual motor protectors

- Remote load handling
- Overload protection
- Phase-loss sensitive
- Temperature compensation
- DIN rail mounting by fixing only one part<sup>1)</sup>
- Manual/local or automatic reset
- Isolation and disconnection functions
- Protection against short-circuit
- High short-circuit interrupting capacity
- Short-circuit tripping device fixed at 13 x lu

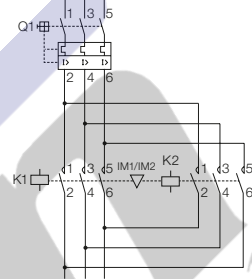
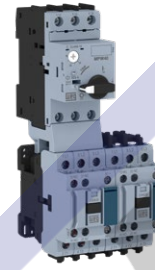

Note: 1) For reversing or star-delta starters, mount the contactors with screws.

Motor current (A)	AC-3 contactor		Motor-protective circuit breaker			Accessories		
	Reference	Maximum rated current AC-3 (A)	Reference	Current I adjustment range (A)	Instantaneous magnetic trip (Im) (A)	Conector	Easy-connection busbar	Mechanical interlock kit
0.1...0.16	CWB9-11-30◆	9	MPW18-3-C016	0.1...0.16	2.0	ECCMP-18B38 (CWB - AC Coil)	EC-R1	IM1
0.16...0.25	CWB9-11-30◆	9	MPW18-3-C025	0.16...0.25	3.2			
0.25...0.4	CWB9-11-30◆	9	MPW18-3-D004	0.25...0.4	5.2			
0.4...0.63	CWB9-11-30◆	9	MPW18-3-C063	0.4...0.63	8.1			
0.63...1	CWB9-11-30◆	9	MPW18-3-U001	0.63...1	13			
1...1.6	CWB9-11-30◆	9	MPW18-3-D016	1...1.6	20.8			
1.6...2.5	CWB9-11-30◆	9	MPW18-3-D025	1.6...2.5	32.5			
2.5...4	CWB9-11-30◆	9	MPW18-3-U004	2.5...4	52			
4...6.3	CWB9-11-30◆	9	MPW18-3-D063	4...6.3	81.9			
6.3...10	CWB12-11-30◆	12	MPW18-3-U010	6.3...10	130			
10...16	CWB18-11-30◆	18	MPW18-3-U016	10...16	208			
16...20	CWB25-11-30◆	25	MPW18-3-U020	16...20	260			
0.1...0.16	CWB9-11-30◆	9	MPW40-3-C016	0.1...0.16	2	ECCMP-40B38 (CWB - AC Coil) ECCMP-40B38DC (CWB - DC Coil)	EC-R1	IM1
0.16...0.25	CWB9-11-30◆	9	MPW40-3-C025	0.16...0.25	3.2			
0.25...0.4	CWB9-11-30◆	9	MPW40-3-D004	0.25...0.4	5.2			
0.4...0.63	CWB9-11-30◆	9	MPW40-3-C063	0.4...0.63	8.1			
0.63...1	CWB9-11-30◆	9	MPW40-3-U001	0.63...1	13			
1...1.6	CWB9-11-30◆	9	MPW40-3-D016	1...1.6	20.8			
1.6...2.5	CWB9-11-30◆	9	MPW40-3-D025	1.6...2.5	32.5			
2.5...4	CWB9-11-30◆	9	MPW40-3-U004	2.5...4	52			
20...25	CWB25-11-30◆	25	MPW40-3-U025	20...25	325			
25...32	CWB32-11-30◆	32	MPW40-3-U032	25...32	416			
32...38	CWB38-11-30◆	38	MPW40-3-U040	32...40	520			
32...40	CWB40-11-30◆	40	MPW80-3-U040	32...40	520			
40...50	CWB50-11-30◆	50	MPW80-3-U050	40...50	650			
50...65	CWB65-11-30◆	65	MPW80-3-U065	50...65	845			
65...80	CWB80-11-30◆	80	MPW80-3-U080	65...80	1,040			
70...90	CWB95-11-30◆	95	MPW100-3-U090	70...90	1,170			
80...95	CWB95-11-30◆	95	MPW100-3-U100	80...100	1,300			
80...100	CWB110-11-30◆	110	MPW100-3-U100	80...100	1,300			
						ECCMP-80B80 (CWB - AC and DC Coil)	EC-R2	IM2
						-	EC-R3	IM2

Notes: Reference values valid for operating voltages up to 440 V, altitude up to 2,000 m, ambient temperature range from -20 °C to +55 °C, and maximum switching frequency up to 15 operations/hour. For other conditions, check the technical data of each part.

Replace "◆" by the appropriate coil voltage code.

### Alternating current (CWB9...110/CAWB)

Code	D02	D07	D13	D23	D24	D25	D33	D34	D35	D36	D39
V (50/60 Hz)	24	48	110	220	230	240	380	400	415	440	480

### Direct current (CWB9...80/CAWB)

Code	C03	C07	C09	C12	C13	C15
V <sub>dc</sub>	24	48	60	110	125	220

### Alternating current/direct current with electronic module (CWB9...125)

Code	E04	E64	E65	E66
V <sub>ac</sub> (50/60 Hz) and V <sub>dc</sub>	24...60 V	48...130 V	110...255 V	250...500 V

# Star-delta starters

## CWB contactors + RW thermal overload relay

- Remote load handling
- Overload protection
- Phase-loss sensitive
- Trip class 10
- Temperature compensation
- DIN rail mounting by fixing the contactors
- Manual/local or automatic reset

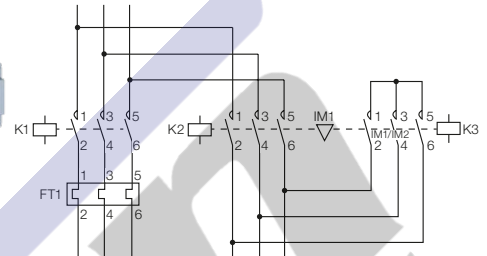
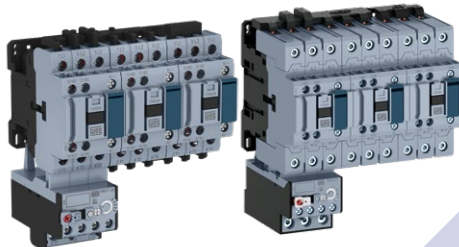

Motor current (A)	AC-3 contactor		Overload relay		Accessories			Fuse
	Contactor Δ (K1 and K2)	Contactor Y (K3)	Reference	Current I adjustment range (A)	Mechanical interlock kit	Easy-connection busbar	Timing relay Y-Δ	Maximum fuse (gL/gG) Coordination type 1
0.5...0.7	CWB9-11-30◆	CWB9-11-30◆	RW27-2D3-D004	0.28...0.4	IM1	EC-SD1	RTW17-G02	2
0.7...1.1	CWB9-11-30◆	CWB9-11-30◆	RW27-2D3-C063	0.4...0.63				2
1.1...1.4	CWB9-11-30◆	CWB9-11-30◆	RW27-2D3-D008	0.63...0.8				2
1.4...2.1	CWB9-11-30◆	CWB9-11-30◆	RW27-2D3-D012	0.8...1.2				4
2.1...3.1	CWB9-11-30◆	CWB9-11-30◆	RW27-2D3-D018	1.2...1.8				6
3.1...4.8	CWB9-11-30◆	CWB9-11-30◆	RW27-2D3-D028	1.8...2.8				6
4.8...6.9	CWB9-11-30◆	CWB9-11-30◆	RW27-2D3-U004	2.8...4				10
6.9...10.9	CWB9-11-30◆	CWB9-11-30◆	RW27-2D3-D063	4...6.3				16
9.6...13.8	CWB9-11-30◆	CWB9-11-30◆	RW27-2D3-U008	5.6...8				20
12.1...17.2	CWB12-11-30◆	CWB9-11-30◆	RW27-2D3-U010	7...10				25
13.8...21.6	CWB18-11-30◆	CWB9-11-30◆	RW27-2D3-D125	8...12.5				25
17.2...25.9	CWB18-11-30◆	CWB9-11-30◆	RW27-2D3-U015	10...15				35
19...29.3	CWB18-11-30◆	CWB12-11-30◆	RW27-2D3-U017	11...17				40
25.9...39.7	CWB25-11-30◆	CWB18-11-30◆	RW27-2D3-U023	15...23				50
37.9...55.2	CWB32-11-30◆	CWB25-11-30◆	RW27-2D3-U032	22...32				63
55.4...65.5	CWB38-11-30◆	CWB25-11-30◆	RW27-2D3-U040	32...40	90			
43.1...69	CWB40-11-30◆	CWB40-11-30◆	RW67- 5D3 -U040	25...40	80			
55.4...86.2	CWB50-11-30◆	CWB40-11-30◆	RW67- 5D3 -U050	32...50	100			
69...98.3	CWB65-11-30◆	CWB40-11-30◆	RW67- 5D3 -U057	40...57	100			
86.2...108.6	CWB65-11-30◆	CWB40-11-30◆	RW67- 5D3 -U063	50...63	100			
98.3...120	CWB80-11-30◆	CWB40-11-30◆	RW67- 5D3 -U070	57...70	125			
109.1...138.4	CWB80-11-30◆	CWB50-11-30◆	RW67- 5D3 -U080	63...80	125			
109.1...138.5	CWB95-11-30◆	CWB95-11-30◆	RW117-3D3-U080	63...80	200			
129.9...164.5	CWB95-11-30◆	CWB95-11-30◆	RW117-3D3-U097	75...97	200			
155.8...190.5	CWB110-11-30◆	CWB95-11-30◆	RW117-3D3-U112	90...112	250			
190.5...216.5	CWB125-11-30◆	CWB95-11-30◆	RW117-3D3-U140	110...140	315			

Notes: Reference values valid for operating voltages up to 440 V, altitude up to 2,000 m, ambient temperature range from -20 °C to +55 °C, and maximum switching frequency up to 15 operations/hour.  
 For other conditions, check the technical data of each part.  
 The electronic timer is not shown in the figure.

Replace "◆" by the appropriate coil voltage code.

### Alternating current (CWB9...110/CAWB)

Code	D02	D07	D13	D23	D24	D25	D33	D34	D35	D36	D39
V (50/60 Hz)	24	48	110	220	230	240	380	400	415	440	480

### Direct current (CWB9...80/CAWB)

Code	C03	C07	C09	C12	C13	C15
V <sub>dc</sub>	24	48	60	110	125	220

### Alternating current/direct current with electronic module (CWB9...125)

Code	E04	E64	E65	E66
V <sub>ac</sub> (50/60 Hz) and V <sub>dc</sub>	24...60 V	48...130 V	110...255 V	250...500 V

# Star-delta starters

## CWB contactors + MPW18 manual motor protectors

- Remote load handling
- Protection against overload
- Phase-loss sensitive
- Temperature compensation
- DIN rail mounting by fixing only one part<sup>1)</sup>
- Manual/local reset
- Isolation and disconnection functions
- Protection against short-circuit
- High short-circuit interrupting capacity
- Short-circuit tripping device fixed at 13 x lu

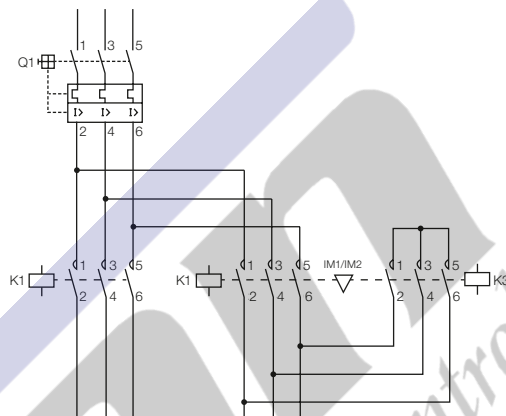
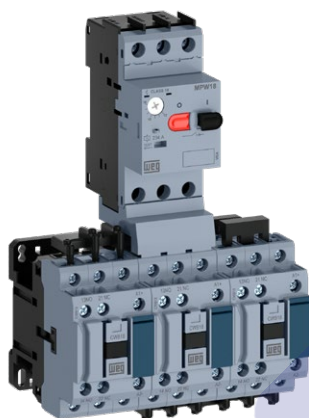

Note: 1) For reversing or star-delta starters, mount the contactors with screws.

Motor current (A)	AC-3 contactor		Motor-protective circuit breaker			Accessories			
	Contactor Δ (K1 and K2)	Contactor Y (K3)	Reference	Current I adjustment range (A)	Instantaneous magnetic trip I <sub>m</sub> (A)	Conector	Mechanical interlock kit	Easy-connection busbar	Timing relay Y-Δ
0.1...0.16	CWB9-11-30◆	CWB9-11-30◆	MPW18-3-C016	0.1...0.16	2.0	ECCMP-18B38 (CWB - AC Coil)	IM1	EC-SD1	RTW17-G02
0.16...0.25	CWB9-11-30◆	CWB9-11-30◆	MPW18-3-C025	0.16...0.25	3.2				
0.25...0.4	CWB9-11-30◆	CWB9-11-30◆	MPW18-3-D004	0.25...0.4	5.2				
0.4...0.63	CWB9-11-30◆	CWB9-11-30◆	MPW18-3-C063	0.4...0.63	8.1				
0.63...1	CWB9-11-30◆	CWB9-11-30◆	MPW18-3-U001	0.63...1	13				
1...1.6	CWB9-11-30◆	CWB9-11-30◆	MPW18-3-D016	1...1.6	20.8				
1.6...2.5	CWB9-11-30◆	CWB9-11-30◆	MPW18-3-D025	1.6...2.5	32.5				
2.5...4	CWB9-11-30◆	CWB9-11-30◆	MPW18-3-U004	2.5...4	52				
4...6.3	CWB9-11-30◆	CWB9-11-30◆	MPW18-3-D063	4...6.3	81.9				
6.3...10	CWB9-11-30◆	CWB9-11-30◆	MPW18-3-U010	6.3...10	130				
10...16	CWB12-11-30◆	CWB9-11-30◆	MPW18-3-U016	10...16	208				
12...18	CWB12-11-30◆	CWB9-11-30◆	MPW18-3-U018	12...18	260				

Notes: Reference values valid for operating voltages up to 440 V, altitude up to 2,000 m, ambient temperature range from -20 °C to +55 °C, and maximum switching frequency up to 15 operations/hour. For other conditions, check the technical data of each part. The electronic timer is not shown in the figure.

Replace “◆” by the appropriate coil voltage code.

Coil voltage codes	D02	D07	D13	D15	D17	D77	D23	D24	D25	D33	D34	D35	D36
V (50/60 Hz)	24	48	110	120	127	208	220	230	240	380	400	415	440

# Star-delta starters

## CWB contactors + MPW40/MPW80/MPW100 manual motor protectors

- Remote load handling
- Protection against overload
- Phase-loss sensitive
- Temperature compensation
- DIN rail mounting by fixing only one part<sup>1)</sup>
- Manual/local or automatic reset
- Isolation and disconnection functions
- Protection against short-circuit
- High short-circuit interrupting capacity
- Short-circuit tripping device fixed at 13 x lu

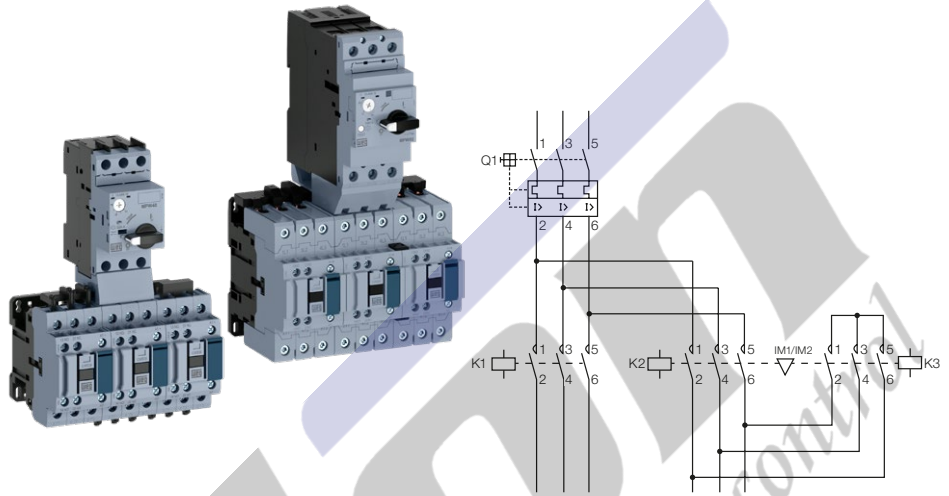

Note: 1) For reversing or star-delta starters, mount the contactors with screws.

Motor current (A)	AC-3 contactor		Motor-protective circuit breaker			Accessories			
	Contactor Δ (K1 and K2)	Contactor Y (K3)	Reference	Current I adjustment range (A)	Instantaneous magnetic trip I <sub>m</sub> (A)	Conector	Mechanical interlock kit	Easy-connection busbar	Timing relay Y-Δ
0.1...0.16	CWB9-11-30◆	CWB9-11-30◆	MPW40-3-C016	0.1...0.16	2.0	ECCMP-40B38 (CWB - AC Coil) ECCMP-40B38DC (CWB - DC Coil)	IM1	EC-SD1	RTW17-G02
0.16...0.25	CWB9-11-30◆	CWB9-11-30◆	MPW40-3-C025	0.16...0.25	3.2				
0.25...0.4	CWB9-11-30◆	CWB9-11-30◆	MPW40-3-D004	0.25...0.4	5.2				
0.4...0.63	CWB9-11-30◆	CWB9-11-30◆	MPW40-3-C063	0.4...0.63	8.1				
0.63...1	CWB9-11-30◆	CWB9-11-30◆	MPW40-3-U001	0.63...1	13				
1...1.6	CWB9-11-30◆	CWB9-11-30◆	MPW40-3-D016	1...1.6	20.8				
1.6...2.5	CWB9-11-30◆	CWB9-11-30◆	MPW40-3-D025	1.6...2.5	32.5				
2.5...4	CWB9-11-30◆	CWB9-11-30◆	MPW40-3-U004	2.5...4	52				
4...6.3	CWB9-11-30◆	CWB9-11-30◆	MPW40-3-D063	4...6.3	81.9				
6.3...10	CWB9-11-30◆	CWB9-11-30◆	MPW40-3-U010	6.3...10	130				
10...16	CWB12-11-30◆	CWB9-11-30◆	MPW40-3-U016	10...16	208				
16...20	CWB12-11-30◆	CWB9-11-30◆	MPW40-3-U020	16...20	260				
20...25	CWB18-11-30◆	CWB9-11-30◆	MPW40-3-U025	20...25	325				
25...32	CWB25-11-30◆	CWB12-11-30◆	MPW40-3-U032	25...32	416				
32...40	CWB25-11-30◆	CWB18-11-30◆	MPW40-3-U040	32...40	520				
40...50	CWB32-11-30◆	CWB18-11-30◆	MPW80-3-U050	40...50	650				
50...65	CWB38-11-30◆	CWB25-11-30◆	MPW80-3-U065	50...65	845				
32...40	CWB40-11-30◆	CWB40-11-30◆	MPW80-3-U040	32...40	520	ECCMP-80B80 (CWB - AC and DC Coil)	IM2	EC-SD2	RTW17-G02
40...50	CWB40-11-30◆	CWB40-11-30◆	MPW80-3-U050	40...50	650				
50...65	CWB40-11-30◆	CWB40-11-30◆	MPW80-3-U065	50...65	845				
65...80	CWB50-11-30◆	CWB40-11-30◆	MPW80-3-U080	65...80	1,040				
55...75	CWB50-11-30◆	CWB40-11-30◆	MPW100-3-U075	55...75	975				
80...95	CWB65-11-30◆	CWB40-11-30◆	MPW100-3-U090	70...90	1,170				
80...100	CWB65-11-30◆	CWB40-11-30◆	MPW100-3-U100	80...100	1,300				

Notes: Reference values valid for operating voltages up to 440 V, altitude up to 2,000 m, ambient temperature range from -20 °C to +55 °C, and maximum switching frequency up to 15 operations/hour. For other conditions, check the technical data of each part. The electronic timer is not shown in the figure.

Replace "◆" by the appropriate coil voltage code.

Coil voltage codes	D02	D07	D13	D15	D17	D77	D23	D24	D25	D33	D34	D35	D36
V (50/60 Hz)	24	48	110	120	127	208	220	230	240	380	400	415	440

Coil voltage codes	C03	C07	C09	C12	C13	C15
V <sub>dc</sub>	24	48	60	110	125	220

## Contactors for lighting circuits

### Contactors for switching illumination circuits

#### Single-phase circuit

Total number of light bulbs shown in the next figure.

#### Three-phase circuit connected in delta

Total number of light bulbs shown in the next figure, multiplied by 1.73 and distributed in three equal quantities.

#### Three-phase circuit connected in star

Total number of light bulbs shown in the next figure, multiplied by 3 and distributed in three equal quantities.

### Diagrams

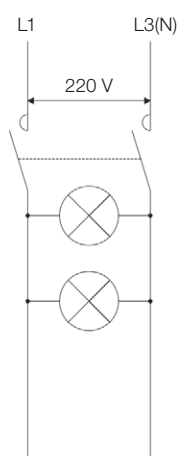

Single-phase circuit

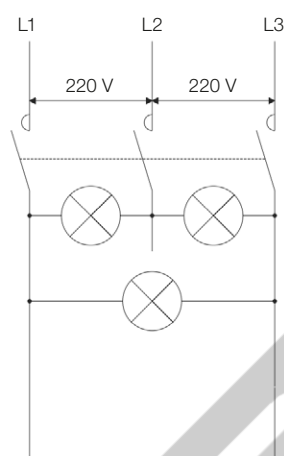

Three-phase circuit connected in delta

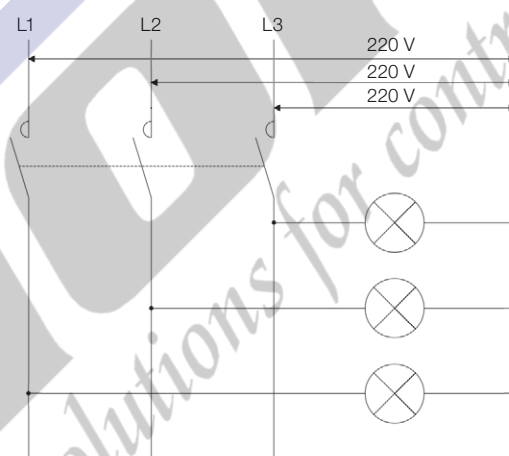

Three-phase circuit connected in star

### Most common characteristics of the illumination systems

#### Incandescent light bulbs

High inrush current ( $\approx 15 \times I_n$ ). Despite the short duration, it must be taken into account so that this current will not be greater than the making capacity of the contactor. Power factor is always 1.

#### Fluorescent lamps

Current slightly above the rated inrush current. Power factor is normally 0.5, and it can be improved up to 0.9 by using capacitors. In some cases, the connection of capacitors must be taken into consideration, as they may cause some damages to smaller contactors.

#### High-pressure mercury-vapor and metal-halide lamps

Inrush current varies according to the lamp type, around  $1.6 \dots 2 \times I_n$  and it remains for 3 to 5 minutes. The power factor is around 0.6 and may be improved up to 1 by using capacitors. In some cases, the connection of capacitors must be taken into consideration, as they may cause some damages to smaller contactors.

#### High-pressure sodium lamps

Inrush current varies according to the lamp type, around  $1.3 \dots 1.6 \times I_n$  and it remains for 3 to 5 minutes. The power factor is around 0.45 and may be improved up to 1 using capacitors. In some cases, the connection of capacitors must be taken into consideration, as they may cause some damages to smaller contactors.



# Contactors for lighting circuits

## Use of contactors in illumination circuits

				Maximum number of lamps per phase at 220 V												
Lamp type	W	A <sup>2)</sup>	µF	CWB9	CWB12	CWB18	CWB25	CWB32	CWB38	CWB40	CWB50	CWB65	CWB80	CWB95	CWB110	CWB125
Incandescent and halogen	60	0.27	-	56	56	67	101	118	135	148	185	241	296	352	407	463
	100	0.45	-	33	33	40	60	71	81	89	111	144	178	211	244	278
	150	0.68	-	22	22	26	40	47	53	59	74	96	118	140	162	184
	200	0.91	-	16	16	19	29	35	40	44	55	71	88	104	121	137
	300	1.4	-	10	10	12	19	22	26	29	36	46	54	68	79	89
	500	2.3	-	6	6	7	11	13	15	17	22	28	35	41	48	54
	750	3.4	-	4	4	5	8	9	10	12	15	19	24	28	32	37
	1,000	4.6	-	3	3	3	5	6	7	9	11	14	17	21	24	27
AC-5b <sup>1)</sup> (A)				15	15	18	28	32	36	40	50	65	80	95	110	125
<b>Fluorescent lamps with electronic starter</b>																
<b>Single arrangement</b>																
Without compensation	20	0.39	-	41	41	53	66	89	112	115	144	187	230	273	316	359
	40	0.45	-	35	35	46	57	77	97	100	124	162	199	236	274	311
	65	0.7	-	22	22	30	37	50	62	64	80	104	128	152	176	200
	80	0.8	-	20	20	26	32	43	55	56	70	91	112	133	154	175
	110	1.2	-	13	13	17	21	29	36	37	47	61	75	89	103	117
With paralel compensation	20	0.17	5	94	94	123	152	205	258	264	329	428	527	626	725	824
	40	0.26	5	61	61	80	100	134	169	172	215	280	345	409	474	538
	65	0.42	7	38	38	50	61	83	104	107	133	173	213	253	293	333
	80	0.52	7	30	30	40	50	67	84	86	108	140	172	205	237	269
110	0.72	16	22	22	29	36	48	61	62	78	101	124	148	171	194	
<b>Dual mounting</b>																
Without compensation	2x20	2x0.22	-	2x36	2x36	2x46	2x58	2x78	2x100	2x102	2x127	2x165	2x204	2x242	2x280	2x318
	2x40	2x0.41	-	2x18	2x18	2x24	2x30	2x42	2x52	2x55	2x68	2x89	2x109	2x130	2x150	2x170
	2x65	2x0.67	-	2x10	2x10	2x14	2x18	2x26	2x32	2x33	2x42	2x54	2x67	2x79	2x92	2x104
	2x80	2x0.82	-	2x8	2x8	2x12	2x14	2x20	2x26	2x27	2x34	2x44	2x55	2x65	2x75	2x85
	2x110	2x1.10	-	2x6	2x6	2x8	2x10	2x14	2x18	2x20	2x25	2x33	2x41	2x48	2x56	2x64
With series compensation	2x20	2x0.13	-	2x60	2x60	2x80	2x100	2x134	2x168	2x172	2x215	2x280	2x345	2x409	2x474	2x538
	2x40	2x0.24	-	2x32	2x32	2x42	2x54	2x72	2x90	2x93	2x117	2x152	2x187	2x222	2x257	2x292
	2x65	2x0.39	-	2x20	2x20	2x26	2x32	2x44	2x56	2x57	2x72	2x93	2x115	2x136	2x158	2x179
	2x80	2x0.48	-	2x16	2x16	2x20	2x26	2x36	2x44	2x47	2x58	2x76	2x93	2x111	2x128	2x146
	2x110	2x0.65	-	2x12	2x12	2x16	2x20	2x26	2x32	2x34	2x43	2x56	2x69	2x82	2x95	2x108
<b>Fluorescent lamps without electronic starter</b>																
<b>Single mounting</b>																
Without compensation	20	0.43	-	37	37	48	60	97	102	104	130	169	208	247	287	326
	40	0.55	-	29	29	38	47	63	80	81	102	132	163	193	224	255
	65	0.8	-	20	20	26	32	43	55	56	70	91	112	133	154	175
	80	0.95	-	16	16	22	27	36	46	47	59	77	94	112	130	147
	110	1.4	-	11	11	15	18	25	31	32	40	52	64	76	88	100
With paralel compensation	20	0.19	5	84	84	110	136	184	231	236	295	383	472	560	648	737
	40	0.29	5	55	55	72	89	101	151	154	193	251	309	367	425	483
	65	0.46	7	34	34	45	56	76	95	97	122	158	195	231	268	304
	80	0.57	7	28	28	36	45	61	77	79	98	128	157	187	216	246
	110	0.79	16	20	20	26	32	44	55	57	71	92	113	135	156	177
<b>Dual mounting</b>																
Without compensation	2x20	2x0.25	-	2x32	2x32	2x42	2x52	2x70	2x88	2x90	2x112	2x146	2x179	2x213	2x246	2x280
	2x40	2x0.47	-	2x16	2x16	2x22	2x26	2x36	2x46	2x48	2x60	2x77	2x95	2x113	2x131	2x149
	2x65	2x0.76	-	2x10	2x10	2x12	2x16	2x22	2x28	2x29	2x37	2x48	2x59	2x70	2x81	2x92
	2x80	2x0.93	-	2x8	2x8	2x10	2x12	2x18	2x22	2x24	2x30	2x39	2x48	2x57	2x66	2x75
	2x110	2x1.3	-	2x6	2x6	2x8	2x10	2x12	2x16	2x17	2x22	2x28	2x34	2x41	2x47	2x54
With paralel compensation	2x20	2x0.14	-	2x56	2x56	2x74	2x92	2x124	2x156	2x16	2x200	2x260	2x320	2x380	2x440	2x500
	2x40	2x0.26	-	2x30	2x30	2x40	2x50	2x66	2x84	2x86	2x108	2x140	2x172	2x205	2x237	2x269
	2x65	2x0.43	-	2x18	2x18	2x24	2x30	2x40	2x50	2x52	2x65	2x85	2x104	2x124	2x143	2x163
	2x80	2x0.53	-	2x14	2x14	2x18	2x24	2x32	2x40	2x42	2x53	2x69	2x85	2x100	2x116	2x132
	2x110	2x0.72	-	2x10	2x10	2x14	2x18	2x24	2x30	2x31	2x39	2x51	2x62	2x74	2x86	2x97

Notes: 1) Orientative values. It is highly recommended to take into account the making capacity values and the AC-1 rated current values when sizing the contactor by the AC-5b utilization category (switching of incandescent lamps).  
 2) Rated current for each lamp at rated voltage.

# Contactors for lighting circuits

## Use of contactors in illumination circuits

Lamp type	W	A	µF	Maximum number of lamps per phase at 220 V												
				CWB9	CWB12	CWB18	CWB25	CWB32	CWB38	CWB40	CWB50	CWB65	CWB80	CWB95	CWB110	CWB125
<b>Low pressure sodium vapor</b>																
Without compensation	35	1.2	-	10	10	12	15	21	27	37	46	60	73	87	101	115
	55	1.6	-	7	7	9	11	16	20	28	34	45	55	65	76	86
	90	2.4	-	5	5	6	7	10	13	18	23	30	37	44	50	57
	135	3.1	-	3	3	4	6	8	10	14	18	23	28	34	39	44
	150	3.2	-	3	3	4	5	8	10	14	17	22	28	33	38	43
	180	3.3	-	3	3	4	5	7	10	14	17	22	27	32	37	42
With paralel compensation	200	3.4	-	3	3	4	5	7	9	13	16	21	26	31	36	40
	35	0.3	17	40	40	50	63	86	110	149	187	243	299	355	411	467
	55	0.4	17	30	30	37	47	65	82	112	140	182	224	266	308	350
	90	0.6	25	-	-	25	31	43	55	75	93	121	149	177	205	233
	135	0.9	36	-	-	-	21	28	36	50	62	81	100	118	137	156
150	1	36	-	-	-	19	26	33	45	56	73	90	106	123	140	
<b>High pressure sodium vapor</b>																
Without compensation	150	1.9	-	6	6	7	10	13	17	21	26	34	42	50	58	66
	250	3.2	-	3	3	4	5	8	10	13	16	20	25	30	34	39
	400	5	-	2	2	3	3	5	6	8	10	13	16	19	22	25
	700	8.8	-	1	1	1	2	2	3	5	6	7	9	11	13	14
	1,000	12.4	-	-	-	1	1	2	2	3	4	5	6	8	9	10
With paralel compensation	150	0.84	20	-	-	17	22	30	39	48	60	77	95	113	131	149
	250	1.4	32	-	-	-	13	18	23	29	36	46	57	68	79	89
	400	2.2	48	-	-	-	8	11	15	18	23	30	36	43	50	57
	700	3.9	96	-	-	-	-	6	8	10	13	17	21	24	28	32
	1,000	5.5	120	-	-	-	-	-	6	7	9	12	15	17	20	23
<b>High pressure mercury vapor</b>																
Without compensation	50	0.54	-	22	22	27	35	48	61	74	93	120	148	176	204	231
	80	0.81	-	14	14	18	23	32	40	49	62	80	99	117	136	154
	125	1.2	-	9	9	12	15	21	27	33	42	54	67	79	92	104
	250	2.3	-	5	5	6	8	11	14	17	22	28	35	41	48	54
	400	4.1	-	2	2	3	4	6	8	10	12	16	20	23	27	30
	700	6.8	-	1	1	2	2	3	4	6	7	10	12	14	16	18
	1,000	9.9	-	1	1	1	1	2	3	4	5	7	8	10	11	13
With paralel compensation	50	0.3	10	40	40	50	63	86	110	133	167	217	267	317	367	417
	80	0.45	10	26	26	33	42	57	73	89	111	144	178	211	244	278
	125	0.67	10	17	17	22	28	38	49	60	75	97	119	142	164	187
	250	1.3	18	9	9	11	14	20	25	31	38	50	62	73	85	96
	400	2.3	25	-	-	6	8	11	14	17	22	28	35	41	48	54
<b>Metal iodide</b>																
Without compensation	250	2.5	-	4	4	6	7	10	12	16	20	26	32	38	44	50
	400	3.6	-	3	3	4	5	7	8	11	14	18	22	26	31	35
	1,000	9.5	-	1	1	1	2	2	3	4	5	7	8	10	12	13
	2,000	20	-	-	-	-	-	1	1	2	3	3	4	5	6	6
With paralel compensation	250	1.4	32	-	-	-	13	18	21	29	36	46	57	68	79	89
	400	2	32	-	-	-	9	13	15	20	25	33	40	48	55	63
	1,000	5.3	64	-	-	-	-	4	6	8	9	12	15	18	21	24
	2,000	11.2	140	-	-	-	-	-	-	4	4	6	7	8	10	11

# Technical data

## Use of contactors in direct current circuits<sup>1)</sup>

### Utilization category DC-1 (L/R ≤1ms)

Models		CWB9	CWB12	CWB18	CWB25	CWB32	CWB38	CWB40	CWB50	CWB65	CWB80	CWB95	CWB110	CWB125
U <sub>e</sub>	Poles in series	Rated operational current I <sub>o</sub> (A)												
≤24 V	1	20	20	25	40	50	50	60	90	110	110	140	150	175
	2	20	20	25	40	50	50	60	90	110	110	140	150	175
	3	20	20	25	40	50	50	60	90	110	110	140	150	175
	4	20	20	25	-	-	-	-	-	-	-	-	-	-
≤48 V	1	20	20	25	40	50	50	60	90	110	110	140	150	175
	2	20	20	25	40	50	50	60	90	110	110	140	150	175
	3	20	20	25	40	50	50	60	90	110	110	140	150	175
	4	20	20	25	-	-	-	-	-	-	-	-	-	-
≤60 V	1	20	20	25	40	50	50	60	90	110	110	140	150	175
	2	20	20	25	40	50	50	60	90	110	110	140	150	175
	3	20	20	25	40	50	50	60	90	110	110	140	150	175
	4	20	20	25	-	-	-	-	-	-	-	-	-	-
≤125 V	1	4	4	4	7	7	7	15	15	15	15	19	22	24
	2	20	20	25	40	50	50	60	90	110	110	140	150	175
	3	20	20	25	40	50	50	60	90	110	110	140	150	175
	4	20	20	25	-	-	-	-	-	-	-	-	-	-
≤220 V	1	1	1	1	1	1	1	2	2	2	2	2.5	2.9	3.2
	2	4	4	4	7	7	7	10	10	10	10	13	15	16
	3	20	20	25	32	32	32	50	50	50	50	64	73	80
	4	20	20	25	-	-	-	-	-	-	-	-	-	-
≤440 V	1	0.4	0.4	0.4	0.4	0.5	0.5	1	1	1	1	1.3	1.5	1.6
	2	1	1	1	1	1	1	2	2	2	2	2.5	2.9	3.2
	3	4	4	4	7	7	7	10	10	10	10	13	15	16
	4	4	4	4	-	-	-	-	-	-	-	-	-	-
≤600 V	1	-	-	-	-	-	-	-	-	-	-	-	-	-
	2	0.4	0.4	0.4	0.4	0.5	0.5	1	1	1	1	1.3	1.5	1.6
	3	1	1	1	1	1	1	2	2	2	2	2.5	2.9	3.2
	4	4	4	4	-	-	-	-	-	-	-	-	-	-

### Utilization category DC-3 (L/R <2.5ms)

Models		CWB9	CWB12	CWB18	CWB25	CWB32	CWB38	CWB40	CWB50	CWB65	CWB80	CWB95	CWB110	CWB125
U <sub>e</sub>	Poles in series	Rated operational current I <sub>o</sub> (A)												
≤24 V	1	18	18	22	36	45	45	55	80	100	100	127	145	159
	2	18	18	22	36	45	45	55	80	100	100	127	145	159
	3	18	18	22	36	45	45	55	80	100	100	127	145	159
	4	18	18	22	-	-	-	-	-	-	-	-	-	-
≤48 V	1	18	18	22	36	45	45	55	80	100	100	127	145	159
	2	18	18	22	36	45	45	55	80	100	100	127	145	159
	3	18	18	22	36	45	45	55	80	100	100	127	145	159
	4	18	18	22	-	-	-	-	-	-	-	-	-	-
≤60 V	1	18	18	22	36	45	45	55	80	100	100	127	145	159
	2	18	18	22	36	45	45	55	80	100	100	127	145	159
	3	18	18	22	36	45	45	55	80	100	100	127	145	159
	4	18	18	22	-	-	-	-	-	-	-	-	-	-
≤125 V	1	2	2	2	3	3	3	5	5	5	5	6.4	7.3	8.0
	2	14.4	14.4	17.6	28.8	36	36	44	64	80	80	102	116	127
	3	18	18	22	36	45	45	55	80	100	100	127	145	159
	4	18	18	22	-	-	-	-	-	-	-	-	-	-
≤220 V	1	0.5	0.5	0.5	0.5	0.5	0.5	1	1	1	1	1.3	1.5	1.6
	2	2	2	2	3	3	3	5	5	5	5	6.4	7.3	8.0
	3	18	18	22	28	28	28	45	45	45	45	57	65	72
	4	18	18	22	-	-	-	-	-	-	-	-	-	-
≤440 V	1	-	-	-	-	-	-	-	-	-	-	-	-	-
	2	0.3	0.3	0.3	0.5	0.5	0.5	1	1	1	1	1.3	1.5	1.6
	3	1.5	1.5	1.5	1.5	3	3	5	5	5	5	6.4	7.3	8.0
	4	3.6	3.6	3.6	-	-	-	-	-	-	-	-	-	-
≤600 V	1	-	-	-	-	-	-	-	-	-	-	-	-	-
	2	-	-	-	-	-	-	-	-	-	-	-	-	-
	3	0.5	0.5	0.5	0.5	0.5	0.5	1	1	1	1	1.3	1.5	1.6
	4	1	2.5	2.5	-	-	-	-	-	-	-	-	-	-

Note: 1) Operating duty according to IEC/EN 60947-4-1:  
 DC-1 (non-inductive or slightly inductive loads, resistive furnaces);  
 DC-3 (shunt-motors: starting, plugging and inching. Dynamic braking of DC motors);  
 DC-5 (series-motors: starting, plugging and inching. Dynamic braking of DC motors).

# Technical data

## Use of contactors in direct current circuits<sup>1)</sup>

### Utilization category DC-5 (L/R ≤15ms)

Models		CWB9	CWB12	CWB18	CWB25	CWB32	CWB38	CWB40	CWB50	CWB65	CWB80	CWB95	CWB110	CWB125
U <sub>e</sub>	Poles in series	Rated operational current I <sub>e</sub> (A)												
≤24 V	1	18	18	22	36	45	45	55	80	100	100	127	145	159
	2	18	18	22	36	45	45	55	80	100	100	127	145	159
	3	18	18	22	36	45	45	55	80	100	100	127	145	159
	4	18	18	22	-	-	-	-	-	-	-	-	-	-
≤48 V	1	18	18	22	36	45	45	55	80	100	100	127	145	159
	2	18	18	22	36	45	45	55	80	100	100	127	145	159
	3	18	18	22	36	45	45	55	80	100	100	127	145	159
	4	18	18	22	-	-	-	-	-	-	-	-	-	-
≤60 V	1	18	18	22	36	45	45	55	80	100	100	127	145	159
	2	18	18	22	36	45	45	55	80	100	100	127	145	159
	3	18	18	22	36	45	45	55	80	100	100	127	145	159
	4	18	18	22	-	-	-	-	-	-	-	-	-	-
≤125 V	1	2	2	2	3	3	3	5	5	5	5	6	7	8
	2	14.4	14.4	17.6	28.8	36	36	44	64	80	80	102	116	127
	3	18	18	22	36	45	45	55	80	100	100	127	145	159
	4	18	18	22	-	-	-	-	-	-	-	-	-	-
≤220 V	1	-	-	-	-	-	-	-	-	-	-	-	-	-
	2	1.6	1.6	1.6	2.4	2.4	2.4	4	4	4	4	5.1	5.8	6.4
	3	16.2	16.2	19.8	25.2	25.2	25.2	40.5	40.5	40.5	40.5	52	59	64
	4	16	16	20	-	-	-	-	-	-	-	-	-	-
≤440 V	1	-	-	-	-	-	-	-	-	-	-	-	-	-
	2	-	-	-	-	-	-	-	-	-	-	-	-	-
	3	0.9	0.9	0.9	0.9	1.8	1.8	3	3	3	3	3.8	4.4	4.8
	4	0.9	0.9	0.9	-	-	-	-	-	-	-	-	-	-
≤600 V	1	-	-	-	-	-	-	-	-	-	-	-	-	-
	2	-	-	-	-	-	-	-	-	-	-	-	-	-
	3	-	-	-	-	-	-	-	-	-	-	-	-	-
	4	-	-	-	-	-	-	-	-	-	-	-	-	-

## Wiring diagrams

### 1 pole in series

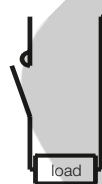

### 3 poles in series

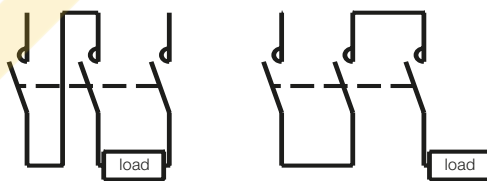

### 2 poles in series

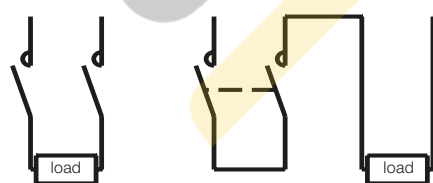



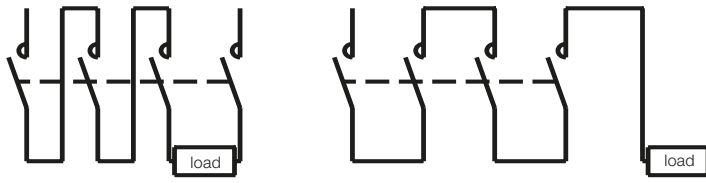

### 4 poles in series

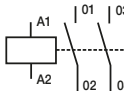
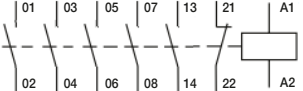
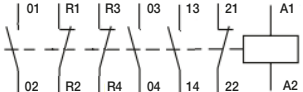
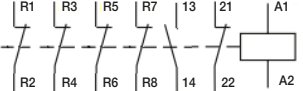
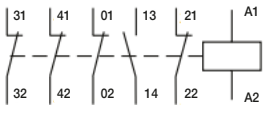
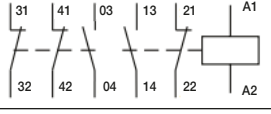
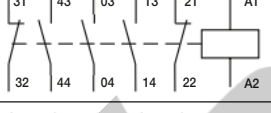
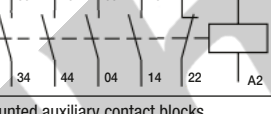

Note: 1) Operating duty according to IEC/EN 60947-4-1:  
 DC-1 (non-inductive or slightly inductive loads, resistive furnaces);  
 DC-3 (shunt-motors: starting, plugging and inching. Dynamic braking of DC motors);  
 DC-5 (series-motors: starting, plugging and inching. Dynamic braking of DC motors).

# Technical data

## Terminal markings according to IEC/EN 60947

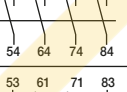
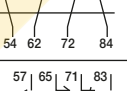
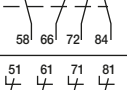
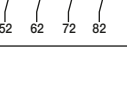
Diagram	Configuration	Auxiliary contacts		Reference
		NO	NC	
<b>3-poles contactors with built-in auxiliary contacts</b>				
	11	1	1	CWB9...125 A CWBxx.11.30◆
	11	1	1	CWBxx.11.40◆
	11	1	1	CWBxx.11.22◆
	11	1	1	CWBxx.11.04◆
<b>Auxiliary contactors</b>				
	14	1	4	CAWB-14-00◆
	23	2	3	CAWB-23-00◆
	32	3	2	CAWB-32-00◆
	41	4	1	CAWB-41-00◆
<b>Front mounted auxiliary contact blocks</b>				
	20	2	0	BFB-20
	11	1	1	BFB-11
	02	0	2	BFB-02
	40	4	0	BFB-40
	22	2	2	BFB-22
	22	2	2	BFB-22 EL
	04	0	4	BFB-04

# Technical data

## Terminal markings according to IEC/EN 60947

Diagram	Configuration	Auxiliary contacts		Reference
		NO	NC	
<b>Front mounted auxiliary contact blocks</b>				
	31	3	1	BFB-31
	13	1	3	BFB-13
<b>Side mounted auxiliary contact blocks</b>				
	11	1	1	BLB-11
	20	2	0	BLB-20
	02	0	2	BLB-02
	11	1	1	BLRB-11
	20	2	0	BLRB-20
	02	0	2	BLRB-02

## Terminal markings according to EN 50012

Diagram	Configuration	Auxiliary contacts		Reference
		NO	NC	
<b>Front mounting auxiliary contact blocks</b>				
	20	2	0	BFB-20 EN
	11	1	1	BFB-11 EN
	02	0	2	BFB-02 EN
	40	4	0	BFB-40 EN
	22	2	2	BFB-22 EN
	04	0	4	BFB-04 EN
	31	3	1	BFB-31 EN
	13	1	3	BFB-13 EN

# Technical data

## Basic data

Models	CAWB	CWB9	CWB12	CWB18	CWB25	CWB32	CWB38		
Compliance with the standards	IEC/EN 60947-1 IEC/EN 60947-4-1 IEC/EN 60947-5-1 UL 60947								
Rated insulation voltage $U_i$ (pollution degree 3)	IEC/EN 60947-4-1 UL, CSA	(V)	690					600	
Rated impulse-withstand voltage $U_{imp}$	IEC/EN 60947-1	(kV)	6						
Frequency limits		(Hz)	25...400						
Mechanical lifespan	AC coil	(million cycles)	10						
	DC coil	(million cycles)	10						
Electrical lifespan	$I_e$ AC-3	(million cycles)	-	2.0	2.0	1.8	1.6	1.6	1.2
Degree of protection (IEC/EN 60529)	Main terminals		IP10 (front)						
	Coil and auxiliary contacts		IP20 (front)						
Mounting	By screws or DIN 35 mm rail (EN 50022)								
Coil connection points	Contactors with AC coil		2						
	Contactors with DC coil		2						
Vibration resistance (IEC/EN 60068-2-6)	Open contactor		(g)					4	
	Closed contactor		(g)					4	
Resistance to mechanical shocks (½ senoide = 11ms - IEC/EN 60068-2-27)	Open contactor		(g)					10	
	Closed contactor		(g)					15	
Ambient temperature	Operating		-25 °C...+55 °C						
	Storage		-55 °C...+80 °C						
Maximum operation altitude without modification in the rated values <sup>1)</sup>	3,000 m								

Models	CWB40	CWB50	CWB65	CWB80	CWB95	CWB110	CWB125		
Compliance with the standards	IEC/EN 60947-1 IEC/EN 60947-4-1 IEC/EN 60947-5-1 UL 60947								
Rated insulation voltage $U_i$ (pollution degree 3)	IEC/EN 60947-4-1 UL, CSA	(V)	1,000					600	
Rated impulse-withstand voltage $U_{imp}$	IEC/EN 60947-1	(kV)	6						
Frequency limits		(Hz)	25...400						
Mechanical lifespan	AC coil	(million cycles)	6						
	DC coil	(million cycles)	6						
Electrical lifespan	$I_e$ AC-3	(million cycles)	1.6	1.6	1.6	1.2	1.1	1.0	1.0
Degree of protection (IEC/EN 60529)	Main terminals		IP10 (front)						
	Coil and auxiliary contacts		IP20 (front)						
Mounting	By screws or DIN 35 mm rail (EN 50022)								
Coil connection points	Contactors with AC coil		2						
	Contactors with DC coil		2						
Vibration resistance (IEC/EN 60068-2-6)	Open contactor		(g)					4	
	Closed contactor		(g)					4	
Resistance to mechanical shocks (½ senoide = 11ms - IEC/EN 60068-2-27)	Open contactor		(g)					10	
	Closed contactor		(g)					15	
Ambient temperature	Operating		-25 °C...+55 °C						
	Storage		-55 °C...+80 °C						
Maximum operation altitude without modification in the rated values <sup>1)</sup>	3,000 m								

Note: 1) For altitudes of 3,000...4,000 m ( $0.90xI_e$  and  $0.80xU_i$ ) and of 4,000...5,000 m ( $0.80xI_e$  and  $0.75xU_i$ ).

## Technical data

### Control circuit - alternating current (AC)

Models			CWB9...38, CAWB	CWB40...80	CWB95/110
Rated insulation voltage $U_i$ (pollution degree 3)	IEC/EN 60947-4-1	(V)	690	1,000	1,000
	UL, CSA	(V)	600	600	600
Standard voltages at 50/60 Hz		(V)	12...500	24...500	24...500
Coil operating limits	At 50 Hz	(xUs)	0.8...1.1	0.8...1.1	0.8...1.1
	At 60 Hz	(xUs)	0.8...1.1	0.8...1.1	0.8...1.1
Average consumption Coil 50/60 Hz (60 Hz operation)	Magnetic circuit closed	(VA)	7.5	17.5	25
	Power factor switched on	(cos $\varphi$ )	0.27	0.28	0.40
	Thermal power dissipation	(W)	1.5...2.5	4...5.5	9...11
	Closing of the magnetic circuit	(VA)	75	185	410
Average consumption Coil 50/60 Hz (50 Hz operation)	Power factor switching on	(cos $\varphi$ )	0.7	0.55	0.48
	Magnetic circuit closed	(VA)	9	27	27
	Power factor switched on	(cos $\varphi$ )	0.24	0.25	0.4
	Thermal power dissipation	(W)	1.5...2.5	5.5...7.8	11...13.4
Average operating time	Closing of the NO contacts	(ms)	15...25	10...15	8...12.5
	Opening of the NO contacts	(ms)	8...12	8...12	4...8

### Control circuit - direct current (DC)

Models			CWB9...38, CAWB	CWB40...80	CWB95...125
Rated insulation voltage $U_i$ (pollution degree 3)	IEC/EN 60947-4-1	(V)	690	1,000	-
	UL, CSA	(V)	600	600	-
Standard voltages		(V)	12...500	12...500	-
Coil operating limits		(xUs)	0.8...1.1	0.8...1.1	-
Average consumption DC coil	Magnetic circuit closed	(W)	5.8	10.6	-
	Closing of the magnetic circuit	(W)	5.8	105.5	-
Average operating time	Closing of the NO contacts	(ms)	35...45	20...30	-
	Opening of the NO contacts	(ms)	8...12	4...8	-

### Control circuit - electronic coils (AC/DC)

Models			CWB9...38, CAWB	CWB40...80	CWB95...125
Rated insulation voltage $U_i$ (pollution degree 3)	IEC 60947-4-1, VDE 0660	(V)	690	1,000	1,000
	UL, CSA	(V)	600	600	600
Standard voltages		(V)	24...500	24...500	24...500
Coil operating limits	at $V_{oc}$	(xUs)	0.8...1.1	0.8...1.1	0.8...1.1
	at 50 Hz	(xUs)	0.8...1.1	0.8...1.1	0.8...1.1
	at 60 Hz	(xUs)	0.8...1.1	0.8...1.1	0.8...1.1
Average consumption			1.0 x Us and cold coil		
AC power supply (60 Hz)	Magnetic circuit closed	(VA)	4.3	5.6	10.8
	Power factor	(cos $\varphi$ )	0.65	0.7	0.47
	Thermal power dissipation	(W)	2.8	3.9	5.1
	Closing of the magnetic circuit	(VA)	19.5	30	217
	Power factor	(cos $\varphi$ )	0.92	0.92	0.88
DC power supply	Magnetic circuit closed	(W)	1...2	2.4...4.8	2...5
	Closing of the magnetic circuit	(W)	10...12	19...21	180...220
Average operating time	Closing of the NO contacts	(ms)	35...60	55...80	32...48
	Opening of the NO contacts	(ms)	35...60	17...37	30...55



# Technical data

## Basic data

Models	CWB150		CWB180	CWB225	
Compliance with the standards			IEC/EN 60947-1 IEC/EN 60947-4-1 IEC/EN 60947-5-1 UL 60947		
Rated insulation voltage $U_i$ (pollution degree 3)	IEC/EN 60947-4-1 UL, CSA	(V)	1,000 600		
Rated impulse-withstand voltage $U_{imp}$	IEC/EN 60947-1	(kV)	8		
Frequency limits			25...400		
Mechanical lifespan	AC/DC coil	(million cycles)	4		
Electrical lifespan	$I_e$ AC-3	(million cycles)	0.6	0.6	0.5
Degree of protection (IEC/EN 60529)	Main terminals		IP00		
	Coil and auxiliary contacts		IP20		
Mounting			By screws		
Coil connection points	Contactors with AC/DC coil		2		
Vibration resistance (IEC/EN 60068-2-6)	Open contactor		(g)		
	Closed contactor		(g)		
Resistance to mechanical shocks (½ senoid = 11ms - IEC/EN 60068-2-27)	Open contactor		(g)		
	Closed contactor		(g)		
Ambient temperature	Operating		-25 °C...+55 °C <sup>1)</sup>		
	Storage		-55 °C...+80 °C		
Maximum operation altitude without modification in the rated values <sup>2)</sup>			3,000 m		

Notes: 1) For temperatures above 50 °C it is necessary to keep the minimum lateral distance of 10 mm to other components.

2) For altitudes of 3,000...4,000 m ( $0.90xI_e$  and  $0.80xU_i$ ) and of 4,000...5,000 m ( $0.80xI_e$  and  $0.75xU_i$ ).

## Control circuit - electronic coils (AC/DC)

Models	CWB150...225			
Standard voltages			(Hz)	24...500
Coil operating limits	at $V_{oc}$		(xUs)	0.8...1.1
	at 50 Hz		(xUs)	0.8...1.1
	at 60 Hz		(xUs)	0.8...1.1
Average consumption				1.0 x Us and cold coil
AC power supply (60 Hz)	Magnetic circuit closed		(VA)	7.9
	Power factor		(cos $\varphi$ )	0.52
	Thermal power dissipation		(W)	4.1
	Closing of the magnetic circuit		(VA)	158
	Power factor		(cos $\varphi$ )	0.58
DC power supply	Magnetic circuit closed		(W)	4.1
	Closing of the magnetic circuit		(W)	91.9



# Technical data

## Main contacts

Models			CWB9	CWB12	CWB18	CWB25	CWB32	CWB38	CWB40	CWB50	CWB65	CWB80	CWB95	CWB110	CWB125	
Rated operational current I <sub>o</sub>	AC-3 (U <sub>e</sub> ≤440 V)	(A)	9	12	18	25	32	38	40	50	65	80	95	110	125	
	AC-4 (U <sub>e</sub> ≤440 V)	(A)	4.4	5.8	8.5	10.4	13.7	13.7	18.5	18.5	26	32	52	58	65	
	AC-1 (θ ≤55 °C, U <sub>e</sub> ≤690 V)	(A)	25	25	32	40	50	50	60	90	110	110	140	150	175	
Rated operational voltage U <sub>e</sub>	IEC/EN 60947-4-1	(V)	690						1,000							
	UL, CSA	(V)	600						600							
Conventional thermal current I <sub>th</sub> (θ ≤55 °C)		(A)	25	25	32	40	50	50	60	90	110	110	140	150	175	
Making capacity - IEC/EN 60947		(A)	250	250	300	450	550	550	550	1,000	1,000	1,000	1,100	1,200	1,375	
Breaking capacity IEC/EN 60947	(U <sub>e</sub> ≤400 V)	(A)	250	250	300	450	550	550	550	1,000	1,000	1,000	1,100	1,200	1,375	
	(U <sub>e</sub> =500 V)	(A)	220	220	250	350	450	450	480	880	880	880	970	1,000	1,200	
	(U <sub>e</sub> =690 V)	(A)	150	150	180	250	350	350	350	640	640	640	700	765	870	
Acceptable short-time current (no current flowing during recovery time of 15min and θ ≤40 °C)	1s	(A)	210	210	240	380	400	430	720	820	900	900	1,200	1,350	1,430	
	10s	(A)	105	105	145	240	260	310	320	400	520	640	720	780	860	
	1min	(A)	60	60	80	120	130	150	165	230	340	360	410	470	515	
	10min	(A)	30	30	40	50	60	60	85	110	130	130	140	150	175	
Short-circuit protection of the main contacts @600 V - UL/CSA		(kA)	5													
	Coordination type 1	(A)	25	40	50	63	63	63	80	100	125	160	224	250	315	
Fuse (gL/gG)	Coordination type 2	(A)	20	20	25	35	50	50	63	80	100	125	160	160	200	
Impedance per pole		(mΩ)	2.5	2.5	2.5	2	2	2	1.6	1.6	1.6	1.6	0.7	0.7	0.7	
Average power dissipation per pole	AC-1	(W)	1.5	1.5	2.5	3.2	5	5	6	13	19	19	15	17	21	
	AC-3	(W)	0.2	0.4	0.8	1.2	2	3	3	4	7	10	7	9	11	
Minimum switching capacity <sup>1)</sup>	(V/mA)		50/100													
<b>Utilization category AC-3</b>																
Rated operational current I <sub>o</sub> (θ ≤55 °C)	U <sub>e</sub> ≤440 V	(A)	9	12	18	25	32	38	40	50	65	80	95	110	125	
	U <sub>e</sub> ≤500 V	(A)	9	12	15.8	23	28.5	28.5	35	45	55	75	84	97	110	
	U <sub>e</sub> ≤690 V	(A)	7	9	12.8	16.5	21	21	32	35	40	50	61	70	80	
Orientative rated operational power Three-phase induction motors (50/60 Hz) IV poles - 1,800 rpm	220/240 V	(kW)	2.2	3	4.5	6.5	7.5	9.2	11	15	18.5	22	22	30	37	
		(cv)	3	4	6	8.7	10	12.5	15	20	25	29	30	40	50	
	380/400 V	(kW)	4	5.5	7.5	12.5	15	18.5	18.5	22	30	37	45	55	55	
		(cv)	5.5	7.5	10	16.8	20	25	25	29	40	50	60	75	75	
	415/440 V	(kW)	4.5	6.5	9.2	12.5	15	18.5	22	30	37	45	55	55	75	
		(cv)	6	8.7	12.5	16.8	20	25	29	40	50	60	75	75	100	
500 V	(kW)	5.5	7.5	10	15	18.5	18.5	22	30	37	55	55	55	75		
	(cv)	7.5	10	13.4	20	25	25	29	40	50	74	75	75	100		
660/690 V	(kW)	5.5	7.5	11	15	18.5	18.5	30	33	37	45	55	55	75		
	(cv)	7.5	10	15	20	25	25	40	44	50	60	75	75	100		
Maximum percentage	600 ops./h	(%)	100	100	100	100	100	100	100	100	100	100	100	100	100	
<b>Utilization category AC-4</b>																
Rated operational current I <sub>o</sub>	(U <sub>e</sub> ≤440 V)	(A)	4.4	5.8	8.5	10.4	14	14	18.5	21	27	40	52	58	65	
	(U <sub>e</sub> ≤500 V)	(A)	3.9	5.1	8	12	13.5	13.5	17.5	17.6	23	33	46	51	57	
	(U <sub>e</sub> ≤690 V)	(A)	2.8	3.7	5.4	12	12.8	12.8	14	17	22	26	33	37	41	
Orientative rated operational power Three-phase induction motors (50/60 Hz) IV poles - 1,800 rpm (200,000 operations)	220/240 V	(kW)	1.5	1.5	2.2	3	4	4	4.5	5.5	7.5	11	15	16.5	18.5	
		(cv)	2	2	3	4	5.4	5.4	6	7.4	10	14.7	20	22	25	
	380/400 V	(kW)	2.2	3.7	4	5.5	7.5	7.5	9.2	11	15	18.5	22	28	30	
		(cv)	3	5	5.4	7.4	10	10	12.3	14.7	20.1	24.8	30	38	40	
	415/440 V	(kW)	2.2	3	3.7	5.5	7.5	7.5	11	11	15	22	30	33	37	
		(cv)	3	4	5	7.4	10	10	14.7	14.7	20.1	30	40	44	50	
500 V	(kW)	2.2	3	5	7.5	9	9	11	15	18.5	22	30	30	37		
	(cv)	3	4	6.7	10	12	12	14.7	20.1	25	30	40	40	50		
660/690 V	(kW)	2.2	3	5	10	11	11	12.5	15	20	25	30	30	45		
	(cv)	3	4	6.7	13.4	14.7	14.7	16.8	20.1	26.8	33.5	40	40	60		

Note: 1) In order to achieve acceptable reliability for application and/or continuity test on the power contacts, a minimum voltage and current of 50 V and 100 mA, respectively, must be used. For lower values, the auxiliary contacts must be used.

# Technical data

## Main contacts

Models			CWB150	CWB180	CWB225
Rated operational current $I_e$	AC-3 ( $U_e \leq 440$ V)	(A)	150	180	225
	AC-4 ( $U_e \leq 440$ V)	(A)	77	96	96
	AC-1 ( $\theta \leq 55$ °C, $U_e \leq 690$ V)	(A)	225	275	320
Rated operational voltage $U_e$	IEC/EN 60947-4-1	(V)		1,000	
	UL, CSA	(V)		600	
Conventional thermal current $I_{th}$ ( $\theta \leq 55$ °C)		(A)	225	275	320
Making capacity - IEC/EN 60947		(A)	1,500	1,800	2,250
Breaking capacity IEC/EN 60947	( $U_e \leq 400$ V)	(A)	1,200	1,440	1,800
Acceptable short-time current (no current flowing during recovery time of 15min and $\theta \leq 40$ °C)	10s	(A)	1,200	1,440	1,800
	30s	(A)	700	830	1,040
	60s	(A)	490	590	735
	180s	(A)	280	340	425
Recovery time (without current)		(min)	15	15	15
Short-circuit breaking capacity		(kA)		10	
Short-circuit protection of the main contacts - Fuse (gL/gG)	Coordination type 1	(A)	355	355	355
	Coordination type 2	(A)	250	250	250
Impedance per pole		(m $\Omega$ )	-	-	-
Average power dissipation per pole	AC-1	(W)	-	-	-
	AC-3	(W)	-	-	-
<b>Utilization category AC-3</b>					
Rated operational current $I_e$ ( $\theta \leq 55$ °C)	$U_e \leq 440$ V	(A)	150	180	225
	$U_e \leq 500$ V	(A)	130	155	185
	$U_e \leq 690$ V	(A)	80	95	135
	$U_e \leq 1,000$ V	(A)	55	80	95
Orientative rated operational power Three-phase induction motors (50/60 Hz) IV poles - 1,800 rpm	220/240 V	(kW)	45	55	55
		(cv)	60	75	75
	380/400 V	(kW)	75	90	110
		(cv)	100	125	150
	415/440 V	(kW)	90	110	132
		(cv)	125	150	175
	500 V	(kW)	90	110	132
		(cv)	125	150	175
660/690 V	(kW)	75	90	132	
	(cv)	100	125	175	
Maximum percentage	600 ops./h	(%)	100	100	100
<b>Fail rates for electrical endurance - AC-3 category (IEC 60947-4-1 appendix K)</b>					
Number of cycles ( $\times 10^6$ )		B10	-	-	-
		B10d	-	-	-
<b>Utilization category AC-4</b>					
Rated operational current $I_e$ ( $\theta \leq 55$ °C)	( $U_e \leq 440$ V)	(A)	77	96	96
	( $U_e \leq 500$ V)	(A)	64	78	78
	( $U_e \leq 690$ V)	(A)	47	77	77
	( $U_e \leq 1,000$ V)	(A)	27	27	32
Orientative rated operational power Three-phase induction motors (50/60 Hz) IV poles - 1,800 rpm	220/240 V	(kW)	22	22	30
		(cv)	30	30	40
	380/400 V	(kW)	30	37	45
		(cv)	40	50	60
	415/440 V	(kW)	45	55	55
		(cv)	60	75	75
	500 V	(kW)	45	55	55
		(cv)	60	75	75
660/690 V	(kW)	45	75	75	
	(cv)	60	100	100	

# Technical data

## Main contacts

Models			CWB9	CWB12	CWB18	CWB25	CWB32	CWB38	CWB40	CWB50	CWB65	CWB80	CWB95	CWB110	CWB125
<b>Utilization category AC-1</b>															
			3P and 4P (NO)												
Conventional thermal current $I_{th}$	$\theta \leq 55^\circ\text{C}$	(A)	25	25	32	40	50	50	60	90	110	110	140	150	175
	$\theta \leq 65^\circ\text{C}$	(A)	20	20	26	32	40	40	48	72	88	88	112	121	140
	$\theta \leq 75^\circ\text{C}$	(A)	18	18	22	28	35	35	42	63	77	77	98	106	123
Maximum orientative operational current according to the ambient temperature	$\theta \leq 55^\circ\text{C}$ ( $U_e \leq 690\text{ V}$ )	(A)	25	25	32	40	50	50	60	90	110	110	140	150	175
Max. operational power $\theta \leq 55^\circ\text{C}$ (three-phase resistors)	240 V	(kW)	10.4	10.4	13.3	16.6	20.8	20.8	24.9	37.4	45.7	45.7	58.2	62.4	72.7
	400 V	(kW)	17.3	17.3	22.2	27.7	34.6	34.6	41.6	62.4	76.2	76.2	97.0	103.9	121.2
	440 V	(kW)	19.1	19.1	24.4	30.5	38.1	38.1	45.7	68.6	83.8	83.8	106.7	114.3	133.4
	500 V	(kW)	21.7	21.7	27.7	34.6	43.3	43.3	52.0	77.9	95.3	95.3	121.2	129.9	151.6
	690 V	(kW)	29.9	29.9	38.2	47.8	59.8	59.8	71.7	107.6	131.5	131.5	167.3	179.3	209.1
Current values for connection	2 poles in parallel		$I_e \times 1.7$												
	3 poles in parallel		$I_e \times 2.4$												
	4 poles in parallel		$I_e \times 3.2$												
Percentage of maximum operational current	600 ops./h	(%)	100	100	100	100	100	100	100	100	100	100	100	100	100

Models			CWB150			CWB180			CWB225		
<b>Utilization category AC-1</b>											
Conventional thermal current $I_{th}$	$(\theta \leq 55^\circ\text{C})$	(A)	225			275			320		
	$(\theta \leq 65^\circ\text{C})$	(A)	180			220			256		
	$(\theta \leq 75^\circ\text{C})$	(A)	158			193			224		
Maximum orientative operational current according to the ambient temperature	$\theta \leq 55^\circ\text{C}$ ( $U_e \leq 690\text{ V}$ )	(A)	225			275			320		
Max. operational power $\theta \leq 55^\circ\text{C}$ (three-phase resistors)	240 V	(kW)	93			114			133		
	400 V	(kW)	155			190			221		
	440 V	(kW)	171			209			243		
	500 V	(kW)	194			238			277		
	690 V	(kW)	268			328			382		
Current values for connection	2 poles in parallel		$I_e \times 1.7$								
	3 poles in parallel		$I_e \times 2.4$								
	4 poles in parallel		-								
Percentage of maximum operational current	600 ops./h	(%)	100								

# Technical data

## Auxiliary contacts

Models			CWB9...125, CAWB (built-in)	BFB (front mounted)	BLB (side mounted)
Compliance with the standards			IEC/EN 60947-5-1		IEC/EN 60947-5-1
Rated insulation voltage $U_i$ (pollution degree 3)	IEC/EN 60947-4-1	(V)	690		690
	UL, CSA	(V)	600		600
Rated operational voltage $U_e$	IEC/EN 60947-4-1	(V)	690		690
	UL, CSA	(V)	600		600
Conventional thermal current $I_{th}$ ( $\theta \leq 55^\circ\text{C}$ )		(A)	10		10
Rated operational current $I_e$					
AC-15 (IEC/EN 60947-5-1)	220/230 V	(A)	6		6
	380/440 V	(A)	4		4
	500 V	(A)	2.5		2.5
	660/690 V	(A)	1.5		1.5
UL, CSA			A600		A600
DC-13 (IEC/EN 60947-5-1)	24 V	(A)	4		4
	48 V	(A)	2		2
	110 V	(A)	0.7		0.7
	220 V	(A)	0.3		0.3
	440 V	(A)	0.15		0.15
	600 V	(A)	0.1		0.1
UL, CSA			Q600		Q600
Making capacity	$U_e \leq 690\text{ V } 50/60\text{ Hz - AC-15}$	(A)	$10 \times I_e$		$10 \times I_e$
Breaking capacity	$U_e \leq 400\text{ V } 50/60\text{ Hz - AC-15}$	(A)	$1 \times I_e$		$1 \times I_e$
Short-circuit protection with fuse (gL/gG)		(A)	10		10
Control circuit reliability		(V / mA)	17 / 5		17 / 5
Electrical lifespan		(million cycles)	1		1
Mechanical lifespan		(million cycles)	10		10
Non-overlapping time between NO and NC contacts		(ms)	1.5		1.5
Impedance of the contacts		(m $\Omega$ )	2.5		2.5



# Technical data

## Terminal capacity and tightening torques

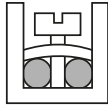
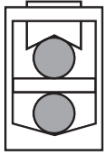
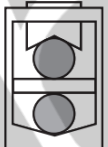
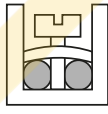
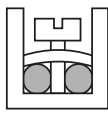
Power circuit						
Model		CWB9...18, CAWB		CWB25...38	CWB40...80	CWB95...125
Mounting system screw type		Phillips number 2		Phillips number 2	4 mm ALLEN	4 mm ALLEN
Flexible conductor without ferrule	(mm <sup>2</sup> )		1 x 1...6	1 x 2.5...10	-	-
			2 x 1...6	2 x 2.5...10	-	-
Flexible conductor with ferrule	(mm <sup>2</sup> )		1 x 1...6	1 x 1.5...10	-	-
			2 x 1...4	2 x 1.5...6	-	-
Solid wire	(mm <sup>2</sup> )		1 x 1...6	1 x 2.5...10	-	-
			2 x 1...6	2 x 2.5...10	-	-
Tightening torque	(Nm)		1.7	2.5	-	-
Flexible conductor without ferrule	(mm <sup>2</sup> )		-	-	1 x 2.5...35	1 x 2.5...70
			-	-	2 x 2.5...35	2 x 2.5...70
Flexible conductor with ferrule	(mm <sup>2</sup> )		-	-	1 x 2.5...35	1 x 2.5...70
			-	-	2 x 2.5...35	2 x 2.5...70
Solid wire	(mm <sup>2</sup> )		-	-	1 x 2.5...35	1 x 2.5...70
			-	-	2 x 2.5...35	2 x 2.5...70
Tightening torque	(Nm)		-	-	5.0	6.0
Power circuit						
Model		CWB150...225_RT				
Mounting system screw type		Allen M8				
Flexible conductor with ferrule	(mm <sup>2</sup> )	2x 50...185				
Busbar - maximum dimensions	(mm)	2x (20x3)				
Tightening torque	(Nm)	24				
Power circuit						
Model		CWB150...225_TB				
Mounting system screw type		Allen M8				
Flexible conductor with ferrule	(mm <sup>2</sup> )		1 or 2x 50...120			
Flexible conductor without ferrule	(mm <sup>2</sup> )		1 or 2x 50...120			
Tightening torque	(Nm)		24			
Control and auxiliary circuit						
Model		CWB9...225, CAWB				
Mounting system screw type		Phillips number 2				
Flexible conductor without ferrule	(mm <sup>2</sup> )		1 x 1...4			
			2 x 1...4			
Flexible conductor with ferrule	(mm <sup>2</sup> )		1 x 1...4			
			2 x 1...2.5			
Solid wire	(mm <sup>2</sup> )		1 x 1...4			
			2 x 1...4			
Tightening torque	(Nm)		1.0			
Auxiliary contact blocks						
Model		BFB (front mounted)		BLB (side mounted)		
Mounting system screw type		Phillips number 2				
Flexible conductor without ferrule	(mm <sup>2</sup> )		1 x 1...2.5			
			2 x 1...2.5			
Flexible conductor with ferrule	(mm <sup>2</sup> )		1 x 1...2.5			
			2 x 1...2.5			
Solid wire	(mm <sup>2</sup> )		1 x 1...2.5			
			2 x 1...2.5			
Tightening torque	(Nm)	1.0				

# Technical data

## Electrical lifespan curves

### Category AC-3 ( $U_e \leq 440$ Vac)

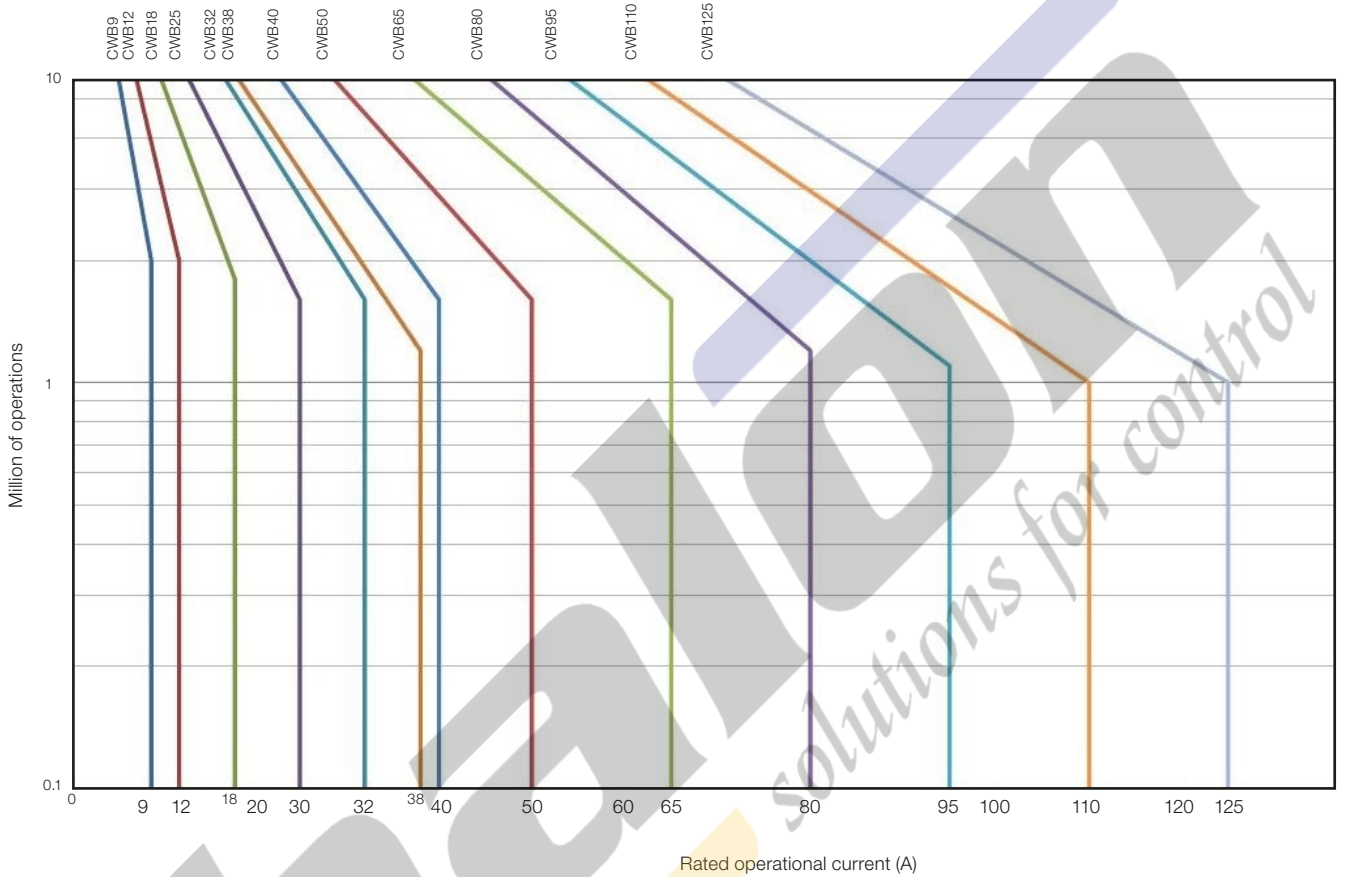

### Category AC-4 and AC-2 ( $U_e \leq 440$ Vac)

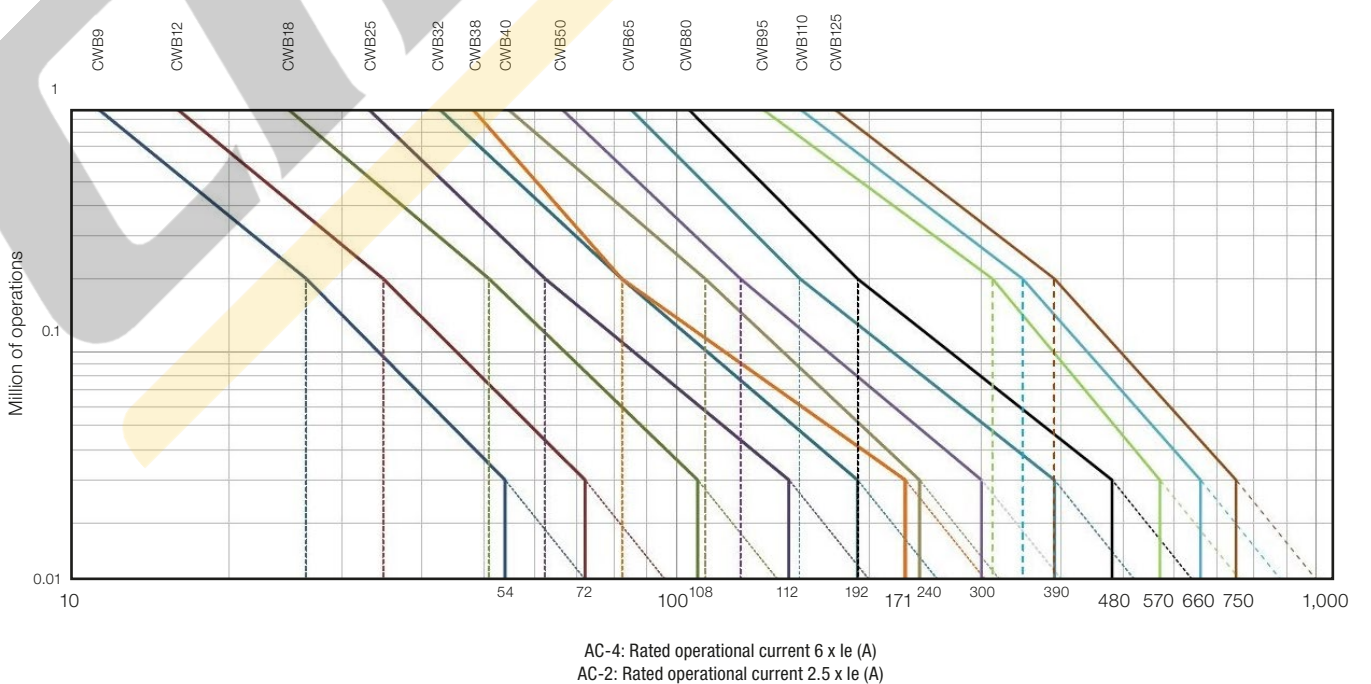

# Technical data

## Electrical lifespan curves

### Category AC-1 ( $U_e \leq 690 \text{ V}_{AC}$ )

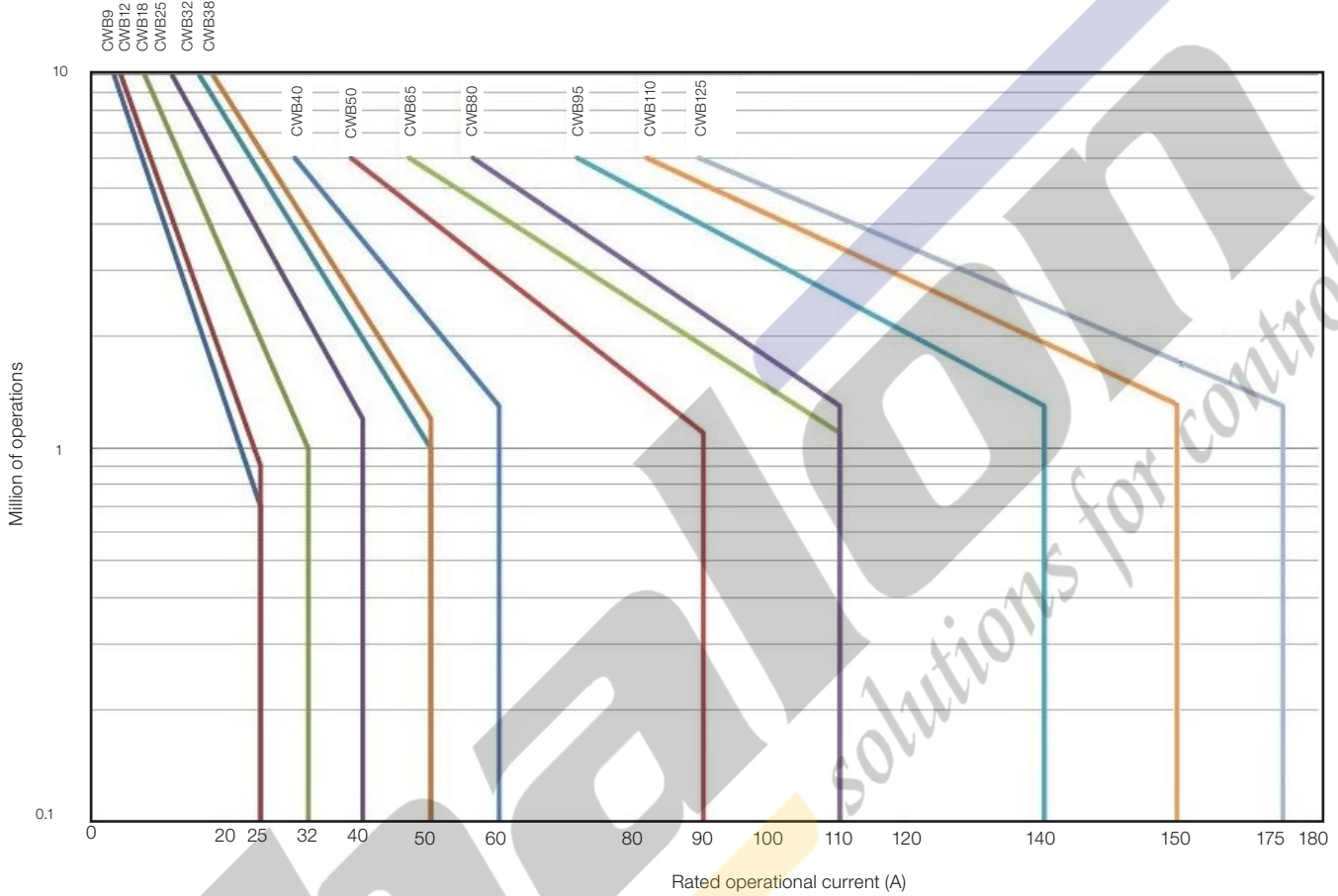

### Category AC-4 and AC-2 ( $U_e \leq 660 / 690 \text{ V}$ )

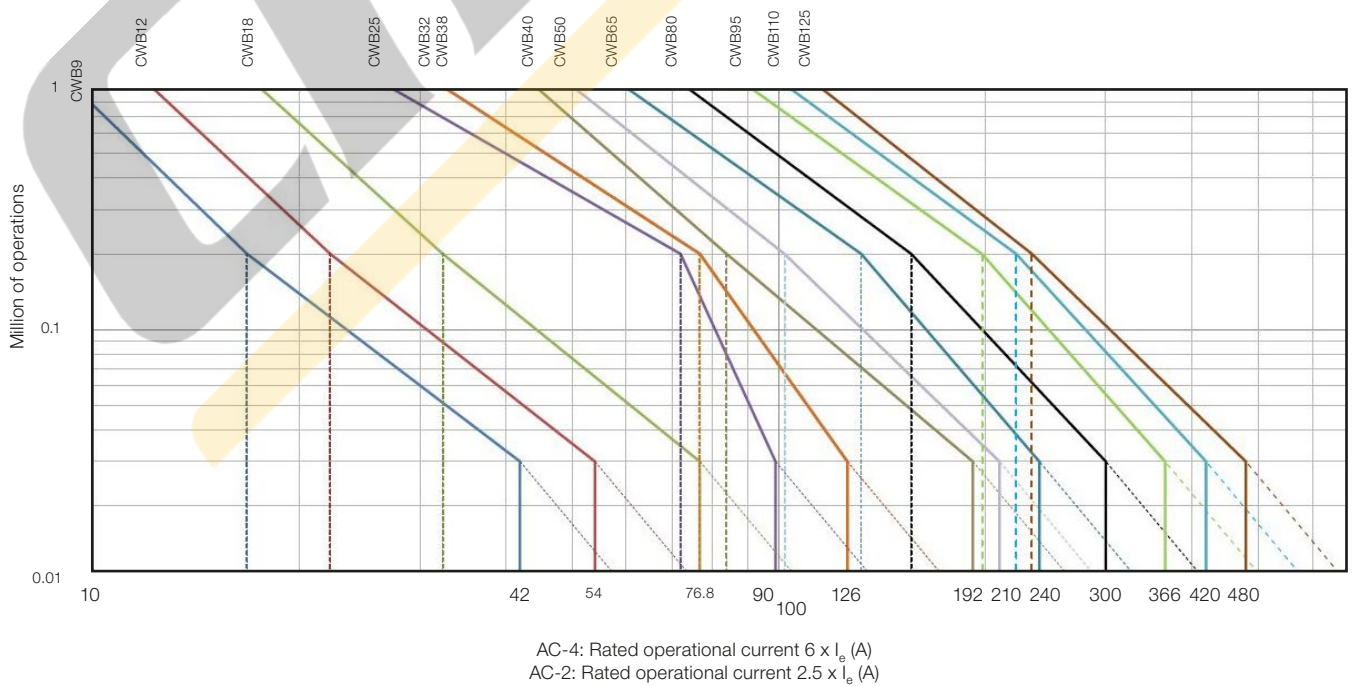



# Dimensions (mm)

## CWB9...38 / CAWB

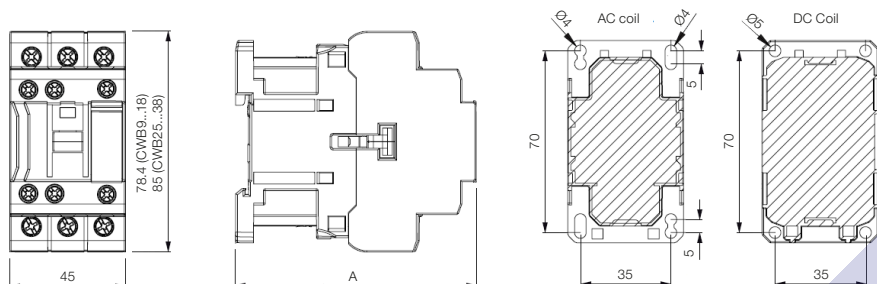

Models	A	
	AC coil	DC coil AC/DC coil
CWB9...18 (3/4 P) CAWB	89.5	98.5
CWB25...38	93	102.2

## CWB40...80

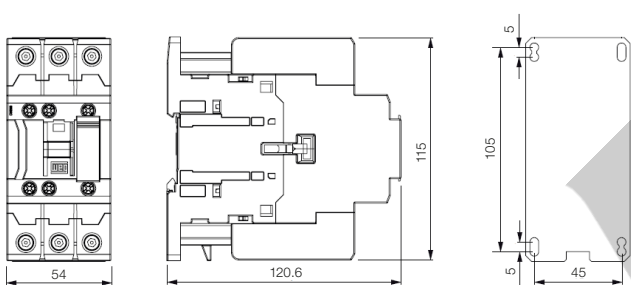

## CWB95...125

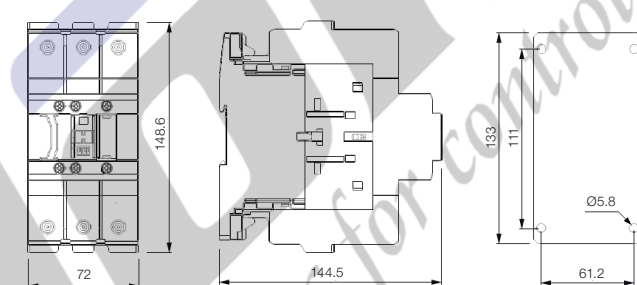

## CWB9...125 / CAWB + BFB (front contact block)

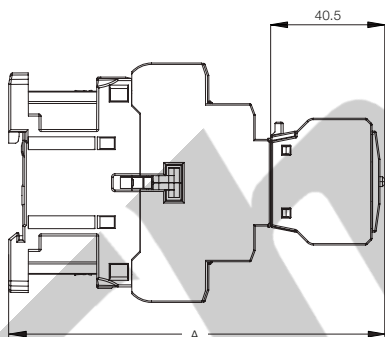

Models	A	
	AC coil	DC coil
CWB9...18 (3/4 P) and CAWB	130	139.2
CWB25...38	133.4	142.6
CWB40...80	161.1	161.1
CWB95...125	184.5	184.5

## CWB9...125 / CAWB + BLB / BLRB (side-mounted contact block)

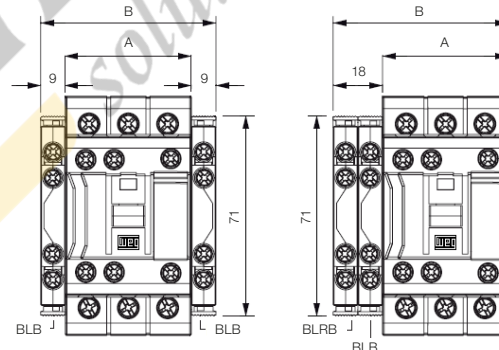

Models	A	B
CWB9...18 (3/4 P) and CAWB	45	63
CWB40...80	54	72
CWB95...125	72	90

## CWB9...125 / CAWB + IM (mechanical interlock)

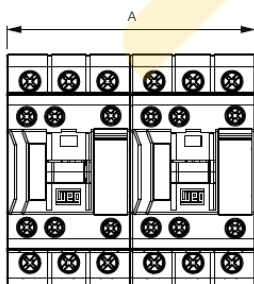

Models	Interlock	A
CWB9...18 CAWB	IM1	90
CWB40...80	IM2	108
CWB95...125		144

## Mounting position CWB9...225 / CAWB

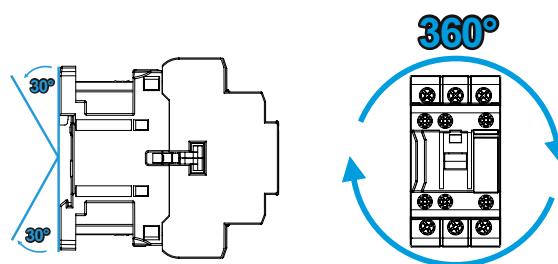

# Dimensions (mm)

## CWB150...225\_RT

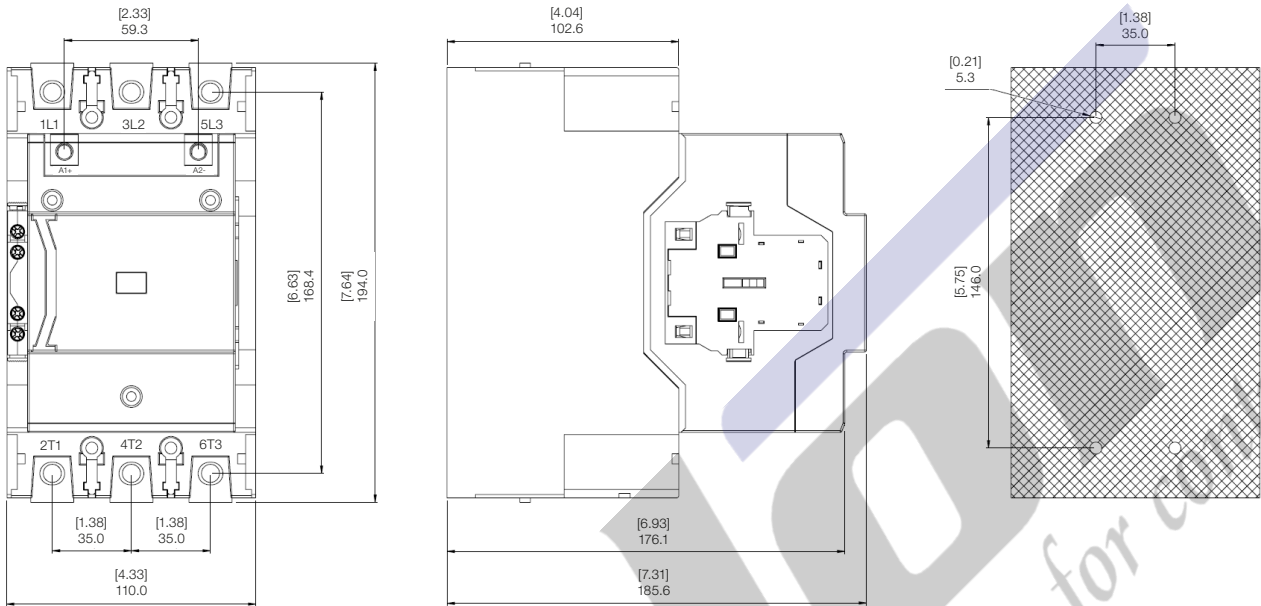

## CWB150...225\_TB

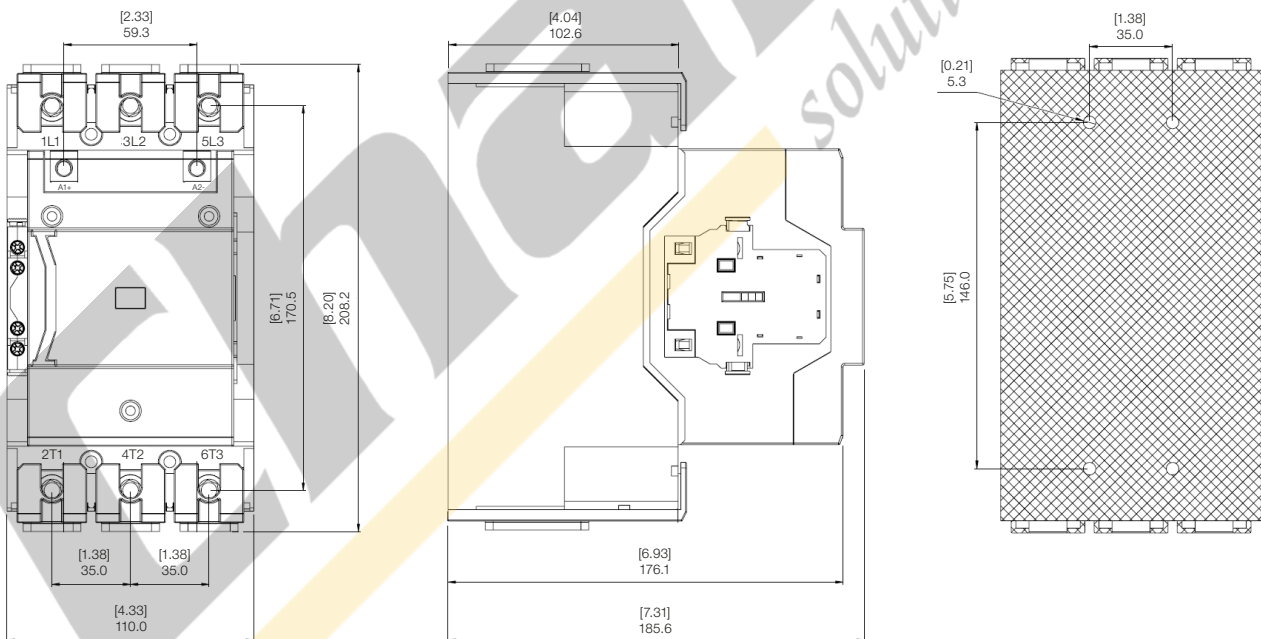

# Dimensions (mm)

## CWB150...225 + IM3

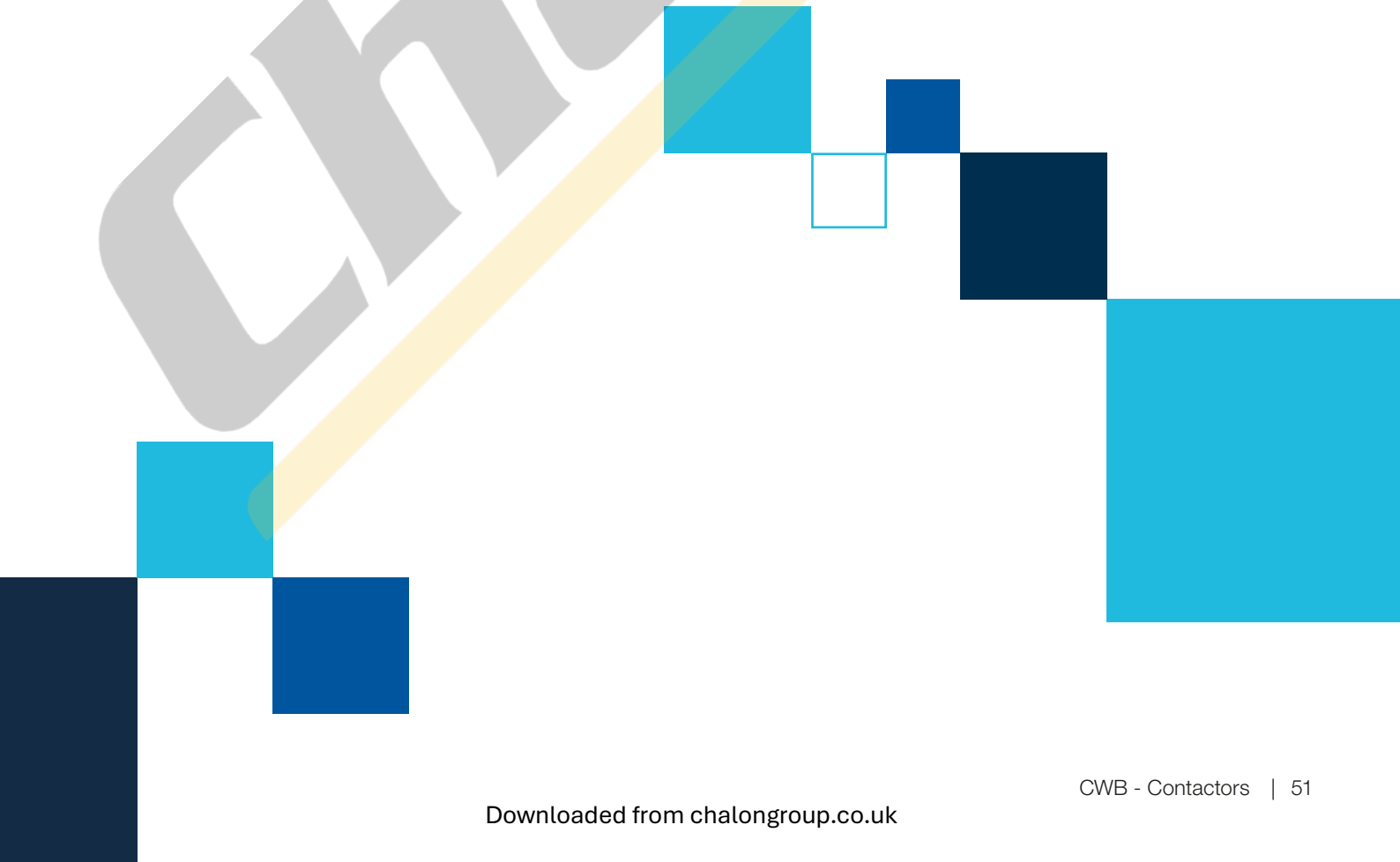
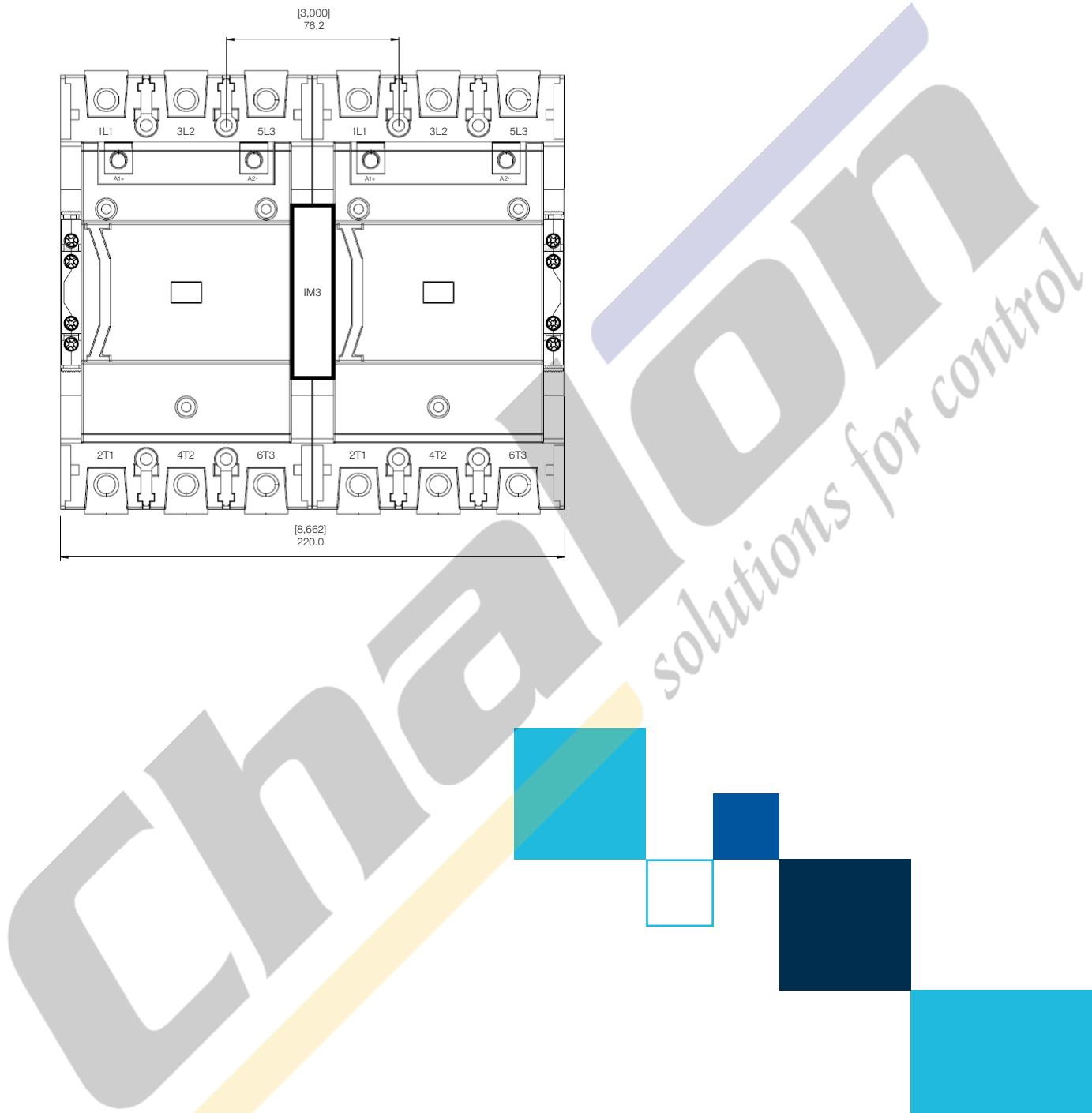
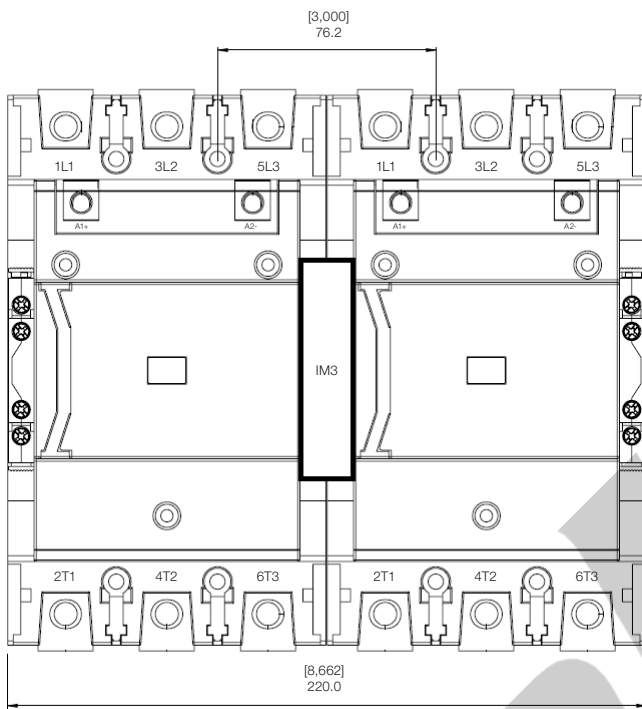

# Dimensions (mm)

## CWB9...38 + MPW18

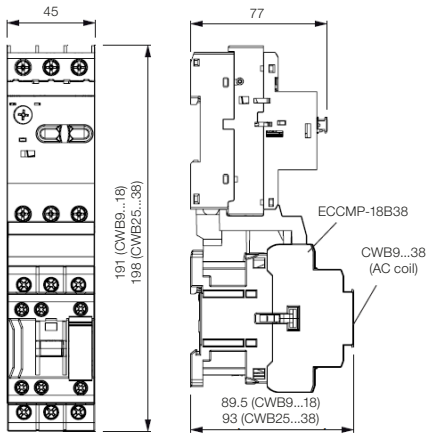

## CWB9...38 + MPW40 CWB40...80 + MPW80

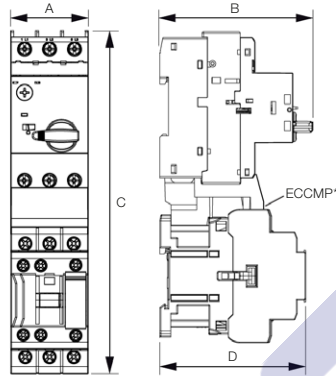

Mounting with MPW40				
A	45			
B	98			
C	AC coil contactor		DC coil contactor	
	CWB9...18	CWB25...38	CWB9...18	CWB25...38
C	191.4	198	191.4	198
D	89.5	93	98.5	102.2
*	ECCMP-40B38		ECCMP-40B38DC	

Mounting with MPW80		
A	54	
B	156.6	
C	AC coil contactor	DC coil contactor
	CWB40...80	CWB40...80
C	263	
D	120.6	
*	ECCMP-80B80	

## CWB9...38 + RW27-2D

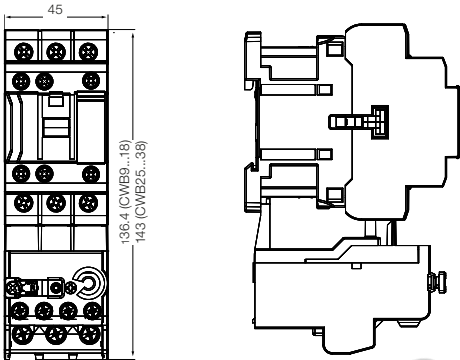

## CWB9...38 + busbar

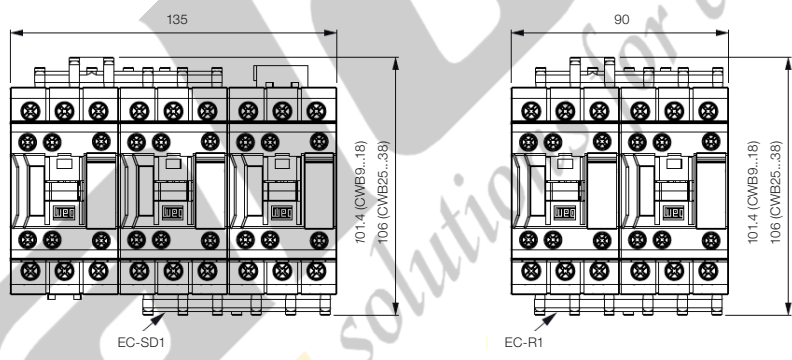

## CWB40...80 + RW67-5D

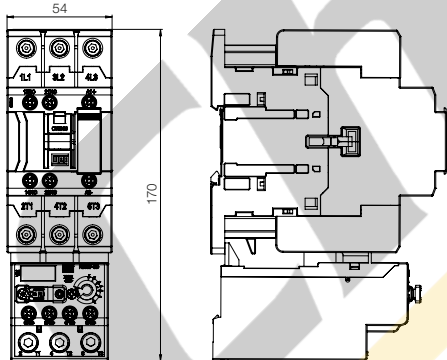

## CWB40...80 + busbar

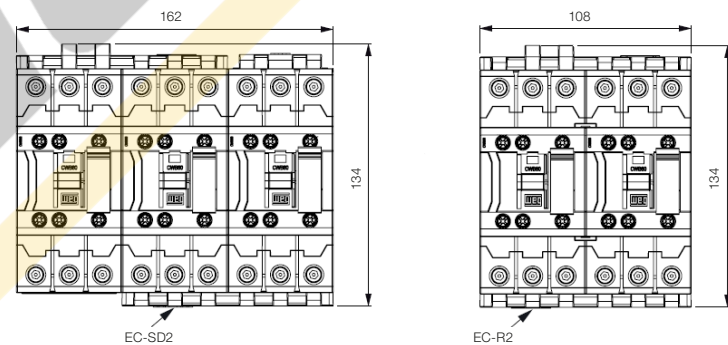

## CWB95...125 + RW117-3D

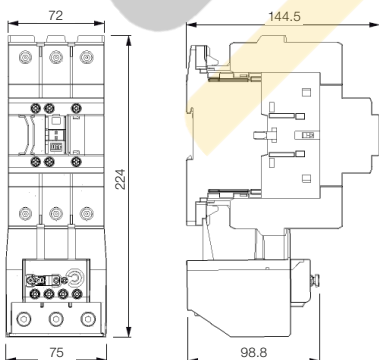



# Global presence

is essential, as much as understanding your needs.

## Global Presence

With more than 40,000 employees worldwide, WEG is one of the largest electric motors, electronic equipments and systems manufacturers. We are constantly expanding our portfolio of products and services with expertise and market knowledge. We create integrated and customized solutions ranging from innovative products to complete after-sales service.

WEG's know-how guarantees our **CWB - Contactors** are the right choice for your application and business, assuring safety, efficiency and reliability.



**Availability** is to have a global support network



**Partnership** is to create solutions that suits your needs



**Competitive edge** is to unite technology and innovation

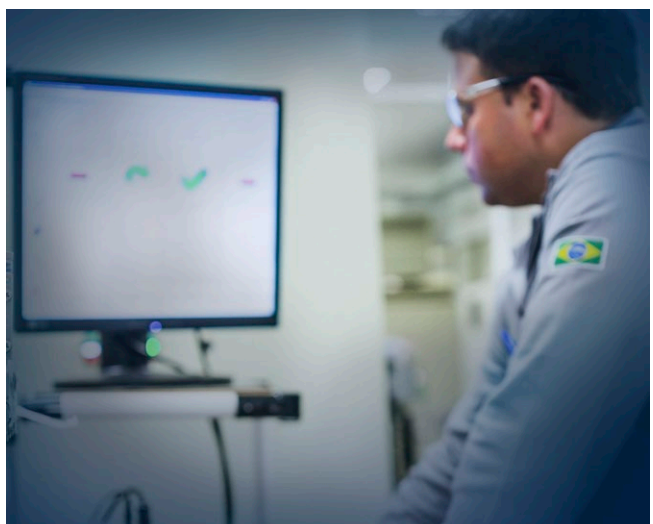
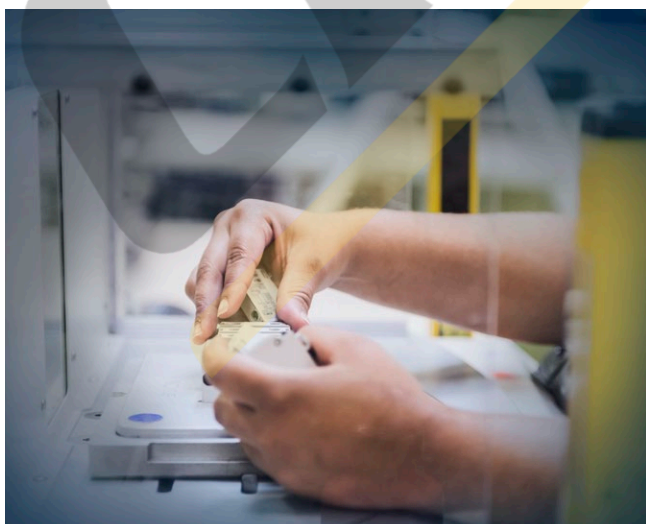

# Know More

High performance and reliable products to improve your production process.

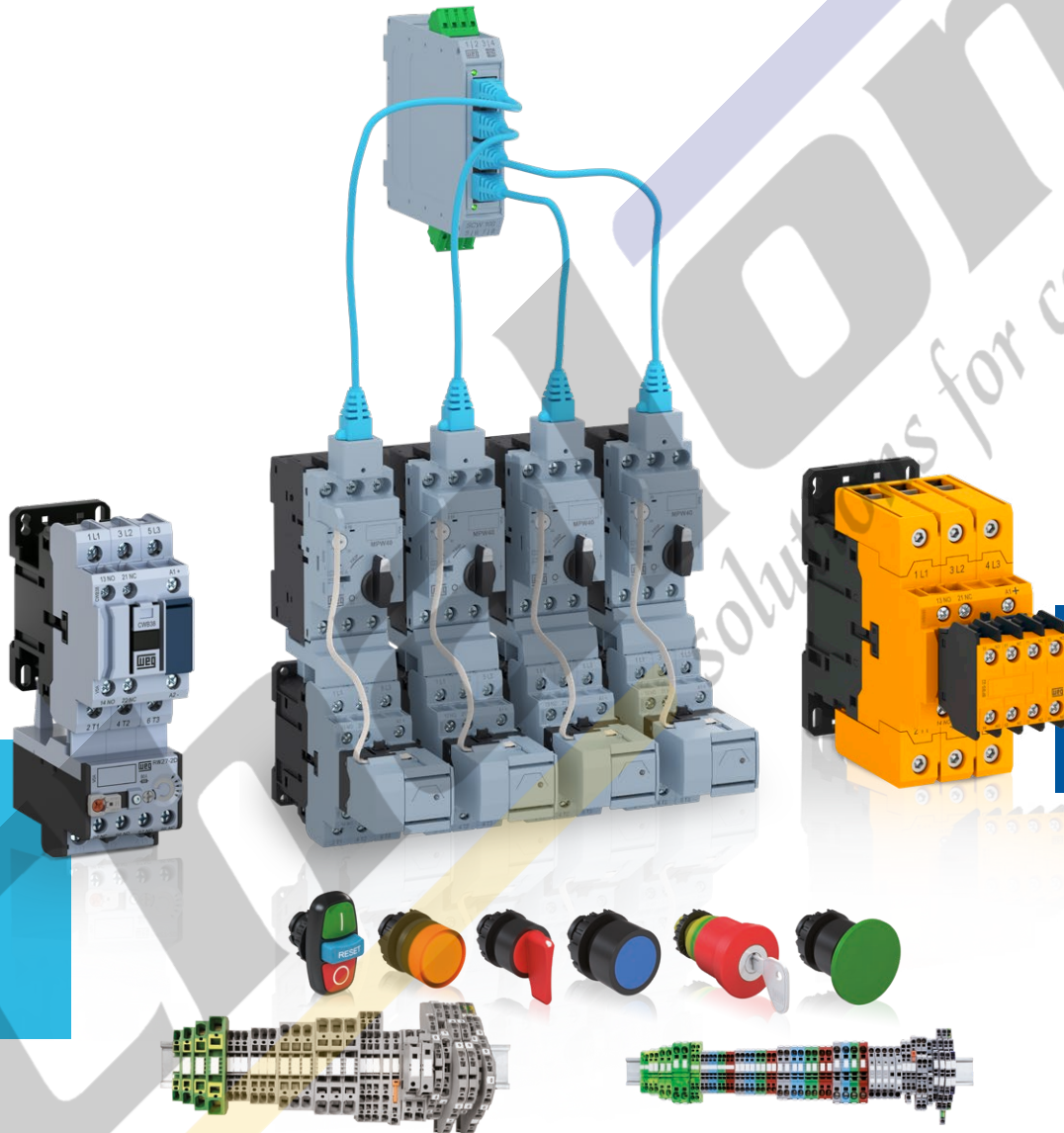

Excellence is to provide a whole solution in industrial automation that improves our customers productivity.

Visit: [www.weg.net](http://www.weg.net)

 [youtube.com/wegvideos](https://youtube.com/wegvideos)

The scope of WEG Group solutions is not limited to products and solutions presented in this catalogue.

**To see our portfolio, contact us.**

**For WEG's worldwide operations visit our website**



**[www.weg.net](http://www.weg.net)**



 +55 47 3276.4000

 [automacao@weg.net](mailto:automacao@weg.net)

 Jaraguá do Sul - SC - Brazil