

CSW LINE PUSH BUTTONS AND PILOT LIGHTS

Variety and functionality in
pushbuttons and pilot lights



Motors | Automation | Energy | Transmission & Distribution | Coatings



CSW Line Pushbuttons and Pilot Lights

Summary

Introduction	04
Overview	12
Front Supply	
Pushbuttons - Non-Illuminated	14
Pushbuttons with Latch - Non-Illuminated	20
Pushbuttons - Illuminated	25
Pilot Lights	28
2-Position Selector Switches - Non-Illuminated	29
3-Position Selector Switches - Non-Illuminated	31
Selector Switches - Illuminated	33
Accessories - Flange Mount	34
PBW Control Stations	39
Accessories - Base/Control Stations Mounting	40
Common Accessories (Flange/Base Mounting)	41
Assembled Units	44
Coding	46
Technical Data	51
Assembly Configurations	53
Installation and Mounting	54
Dimensions	56

Variety and functionality in pushbuttons and pilot lights



The CSW line of Pushbuttons and Pilot Lights was **carefully developed** to meet the **operation and signaling** requirements in a wide range of industrial applications.

All items of the line have been designed and present performance **according to the IEC 60947-5-1 and UL 508** standards, allowing their **application on machines and electrical panels** intended for **the most demanding markets of the world**.



solutions for control



Pushbuttons and Pilot Lights - CSW Line (Ø22 mm) - IP66

Design and Construction

In order to ensure a high quality standard and provide reliable performance for the control and signaling circuits, the products of the CSW line are made with high-end materials.

Their anatomical design allows easy understanding and operation.

The CSW line is also characterized by the robustness, reliability and excellent cost effectiveness. 100% produced in Brazil, the CSW line is a world-class WEG product available for its customers worldwide.



Manufactured in Brazil

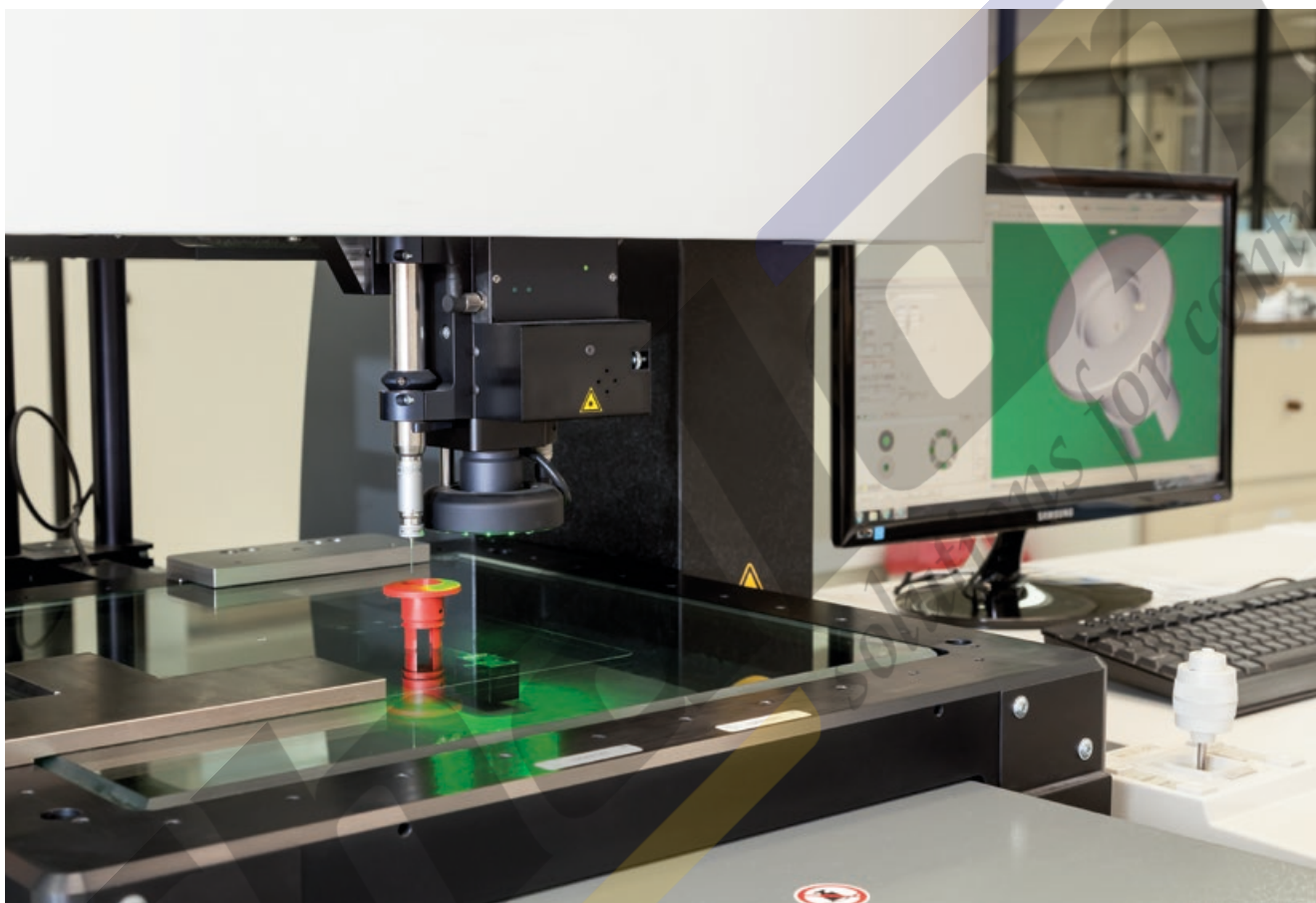

Safety and Reliability

The CSW line offers IP66 protection rating, according to IEC 60529 and NEMA 4X as per UL 508, providing proper performance even in environments where contaminants such as dust and humidity are present.

All the CSW line is manufactured with non-flammable and UV-ray-protected materials to ensure safety and reliability in applications outdoors and in aggressive environments.



Non-flammable



UV-protected

IP66
(NEMA 4X)

Protected against
dust and water jets



Easy Assembly

The coupling system of WEG contact or illumination blocks to frontal parts (pushbuttons, selector switches or pilot lights) is made by quick assembly using a dedicated mounting flange with 3 or 5 positions, without requiring any tools. The quick-connecting flanges are installed on the frontal parts with just a click, and they can also be uninstalled from the frontal parts without any tools.



Self-Cleaning and High-Performance Contact Blocks

The contacts of the CSW line are manufactured with special silver alloys, ensuring high reliability and performance to the control circuits, with low current and voltage levels (5 mA / 17 V dc). WEG contact blocks are self-cleaning, which prevents the internal oxidation of the contacts and ensures better electric conductivity to the circuit. In compliance with the requirements of national and international occupational safety standards, such as NR12, the NC contact blocks feature positive opening, which ensures the opening of the contact by means of direct action, regardless of any event, such as contact welding.

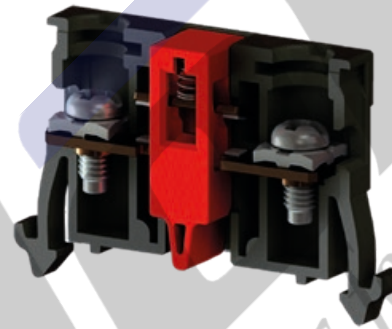

Positive opening

Different Applications

WEG has a full line of solutions in order to solve challenging industrial applications. The Pushbuttons and Pilot Lights portfolio includes different types of buttons: double, triple and illuminated (LED technology) pushbuttons, emergency-stop pushbuttons and many other options, together with a wide range of accessories. There are several function and engraving options.



Front-Back Assembly Systems and the New Contact Blocks

By means of special snap fits, the contact blocks can be front-back assembled. This new mounting system allows greater flexibility on contact combination resulting in inventory reduction, since the old double contact blocks are no longer necessary. The AF3F or AF5F flange models must be used for the front-back assembly of contact blocks. The new contact blocks that allow front-back assembly are easily distinguished from traditional blocks due to their new shape and blue color. The AF3F and AF5F flanges are distinguished by the blue color.

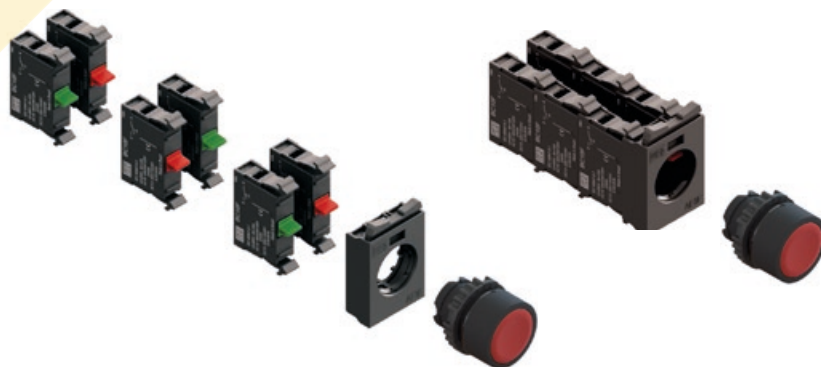

Pushbuttons and Pilot Lights - CSW Line (Ø22 mm) - IP66

PBW Decentralized Control Stations

With a modern design, the PBW control stations are compact and solve a great variety of challenging applications. Manufactured with high-end materials, they ensure excellent performance to applications that require great resistance against impact and bad weather. Their use with frontal parts of the CSW pushbuttons and pilot lights line allows different functions, such as: emergency stop, signaling, starts, stops, among others.



Main Features and Benefits

- IP66/NEMA 4X protection rating: special sealing gaskets assures the water tightness and the protection rating throughout the product life cycle.
- Several cable entries: different knock-out type entries on sides and base, supporting different cable glands with different threads.
- Exclusive ID plate holding system: integrated to the control station, it allows for standard CSW legend.
- Captive fixing screws: ensure safe and easy installation and maintenance.
- Robustness: manufactured in high-performance, non-flammable and UV-protected polycarbonate. Due to their mechanical construction, they offer outstanding resistance to aggressive environments and impacts.
- Special base-mount contact and illumination blocks provide easy installation.
- Safety against electric shocks: manufactured with materials that provide full insulation of live parts, they ensure greater safety to the user without the risk of electric shocks.



Captive screw system



Exclusive ID plate holding system



IP66 (NEMA 4X) *Protected against dust and water jets*



UV-protected



Totally insulated



Resistant to impacts



Non-flammable

Pushbuttons and Pilot Lights - CSW Line (Ø22 mm) - IP66

Self-Monitoring of Emergency-Stop Pushbuttons

- Emergency-stop pushbuttons are one of the most common and important devices to actuate the emergency stop and indicate dangerous situations on machine and equipment panels. However, if this device is not properly installed, its function will be compromised, and it may put users at risk.
- The BCM01F-CSW monitoring block was developed so as to ensure greater safety to those applications. Its application with the emergency-stop pushbuttons of the BESG/P/Y line ensures proper installation and provides greater reliability for emergency stop systems. When properly fit, WEG emergency-stop pushbuttons prevent inadvertent start or stop.
- Developed according to international IEC 60947-5-5 and UL 508 standards and the Brazilian NR12 standard. Combined with the other collective protective equipment (CPE), it ensures greater safety to your application.



Flange **NOT** properly assembled on the pushbutton.



Block **NOT** properly assembled on the flange.



Correct assembly.

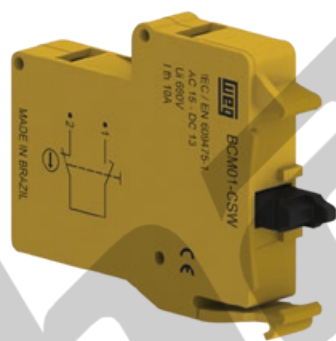

Electric Diagram

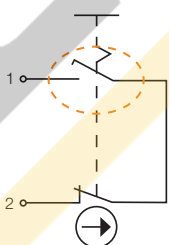

NO contact only closes when the mechanical assembly is correct. When the button is actuated or removed from its position, the NO contact opens and interrupts the electric circuit.

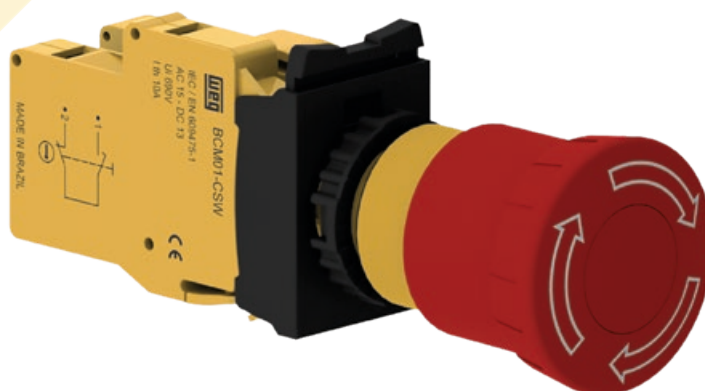

Pushbuttons and Pilot Lights - CSW Line (Ø22 mm) - IP66

Self-Monitoring of Emergency-Stop Pushbuttons

BESGM, BESPM and BESYM emergency-stop pushbuttons allow monitoring the mechanical assembly using single contact blocks in flange or PBW control station mounting. The CBCSW contact block tie enables turning all the items into a single set, ensuring greater safety and reducing the possibility of operation faults. The only national manufacturer with emergency-stop pushbutton monitoring system mounted in plastic control stations with base-mount contact blocks, ensuring more compact and efficient solutions to your application.

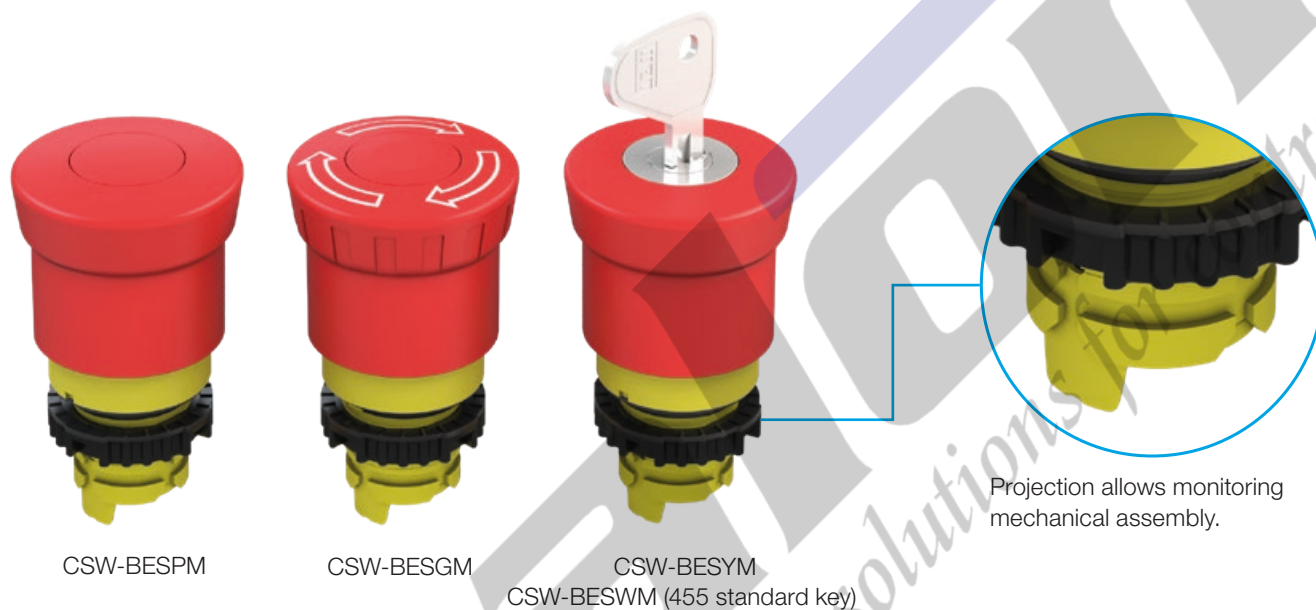

Mounting of the Self-Monitoring System in Flange with Front-Back System

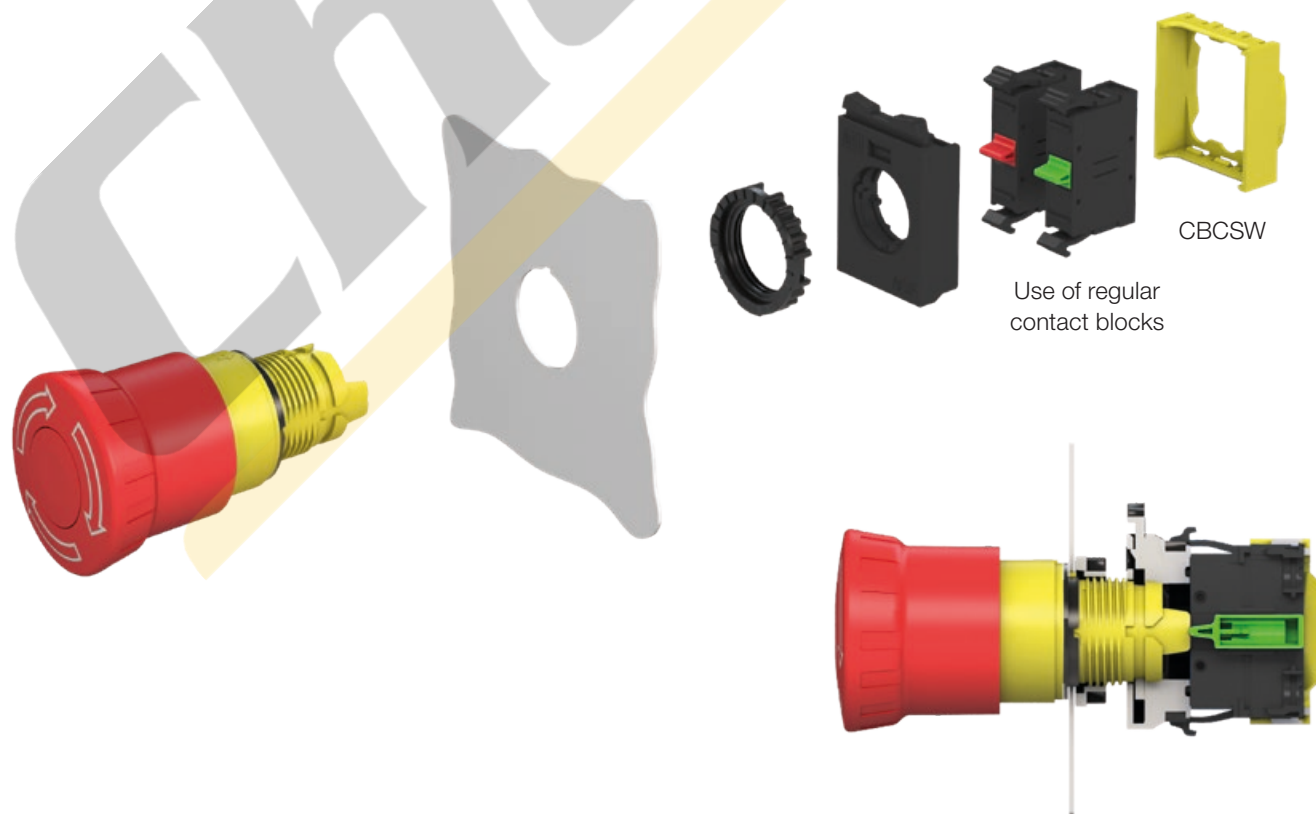

Pushbuttons and Pilot Lights - CSW Line (Ø22 mm) - IP66

Mounting of the Self-Monitoring System in PBW Control



Electric Diagram

NO contact closes when the mechanical mounting is correct.

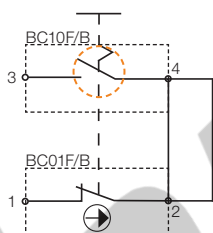

Assembly

Monitored



0°

Non-monitored



90°
180°
270°

According to the installation of the emergency-stop pushbutton, it allows choosing the monitoring.

High Performance Illumination Blocks

High brightness LEDs ensure illumination and efficiency (lumens/Watt), with low heat dissipation and energy consumption. Its integrated construction provides high mechanical resistance to vibrations and maintenance-free operation. Its useful life is much longer than illumination by Ba9s-type conventional incandescent lamps.



Certifications

- The products of the CSW line bear several certifications for a great variety of markets and applications.

Overview of Pushbuttons and Pilot Lights - CSW Line (Ø22 mm) - IP66

N°	Description
1	Double pushbutton
2	Protection cover for double pushbutton
3	Illuminated single pushbutton
4	Single pushbutton
5	Protection cover for single pushbutton
6	Selector switch knob
7	Selector switch lever
8	Illuminated selector switch
9	Selector switch - key release
10	Pilot light
11	Mushroom selector switch
12	Mushroom button - twist-to-release
13	Mushroom pushbutton - key release
14	Plate holder
15	Plate
17	Illumination block
18	Single contact block
19	NC late-break single contact block
20	Push-on/push-off block
21	NO early-make single contact block
22	3-position flange
23	5-position flange
24	Illuminated extended pushbutton
25	Illuminated mushroom selector switch
26	Guarded pushbutton
27	Protection cover for the single pushbutton illumination and extended
28	Plate holder double pushbutton
29	Sealing ring
30	Protection
31	Emergency-stop - twist-to-release (BESG)
32	Emergency-stop - pull-to-release (BESP)
33	Emergency-stop - key release (BESY)
34	Self-monitoring block
35	Double pushbutton IP66
36	Reset pushbutton with shaft BH
37	Mushroom pushbutton - key release (455 standard)
38	Selector switch - key release (standard 455)
39	Emergency-stop - key release BESW (455 standard)
40	Heavy duty mushroom pushbutton (BCHD)

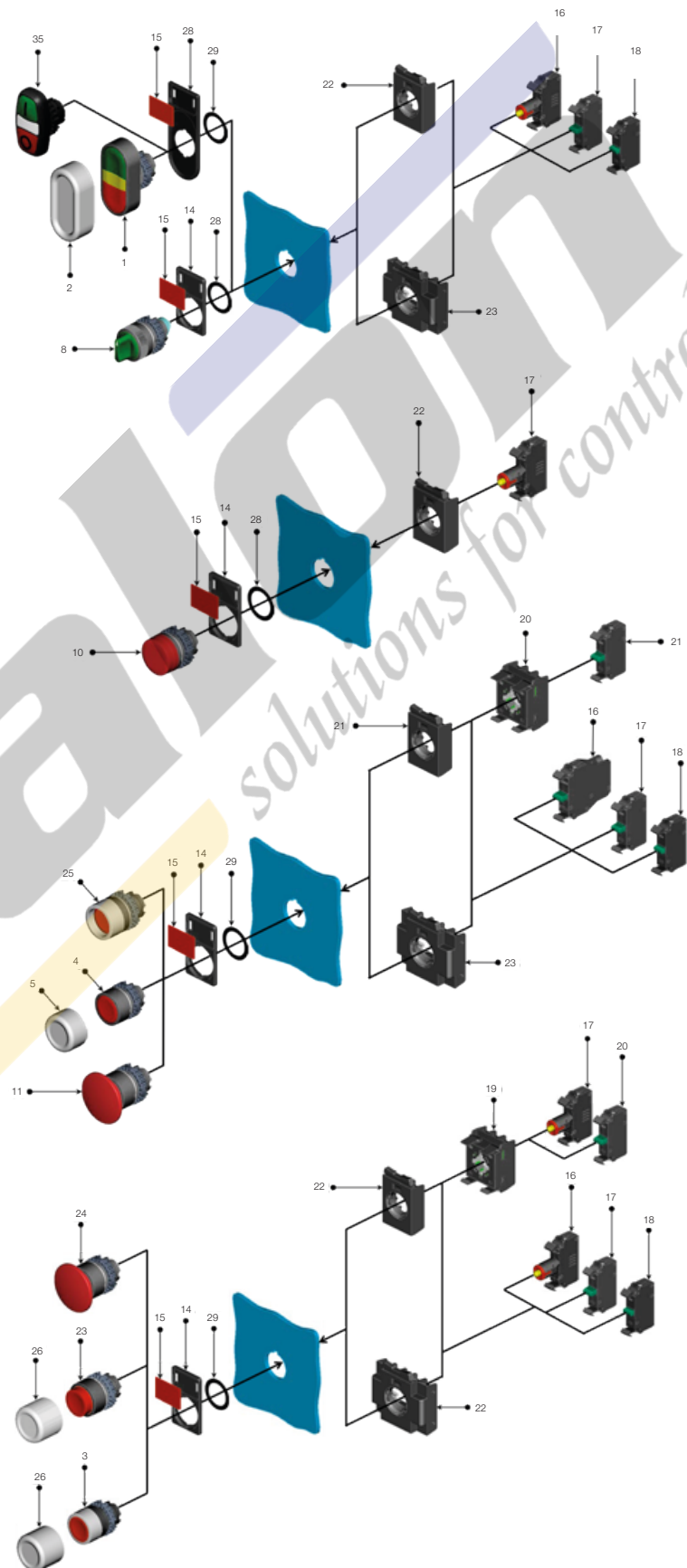

Overview of Pushbuttons and Pilot Lights - CSW Line (Ø22 mm) - IP66

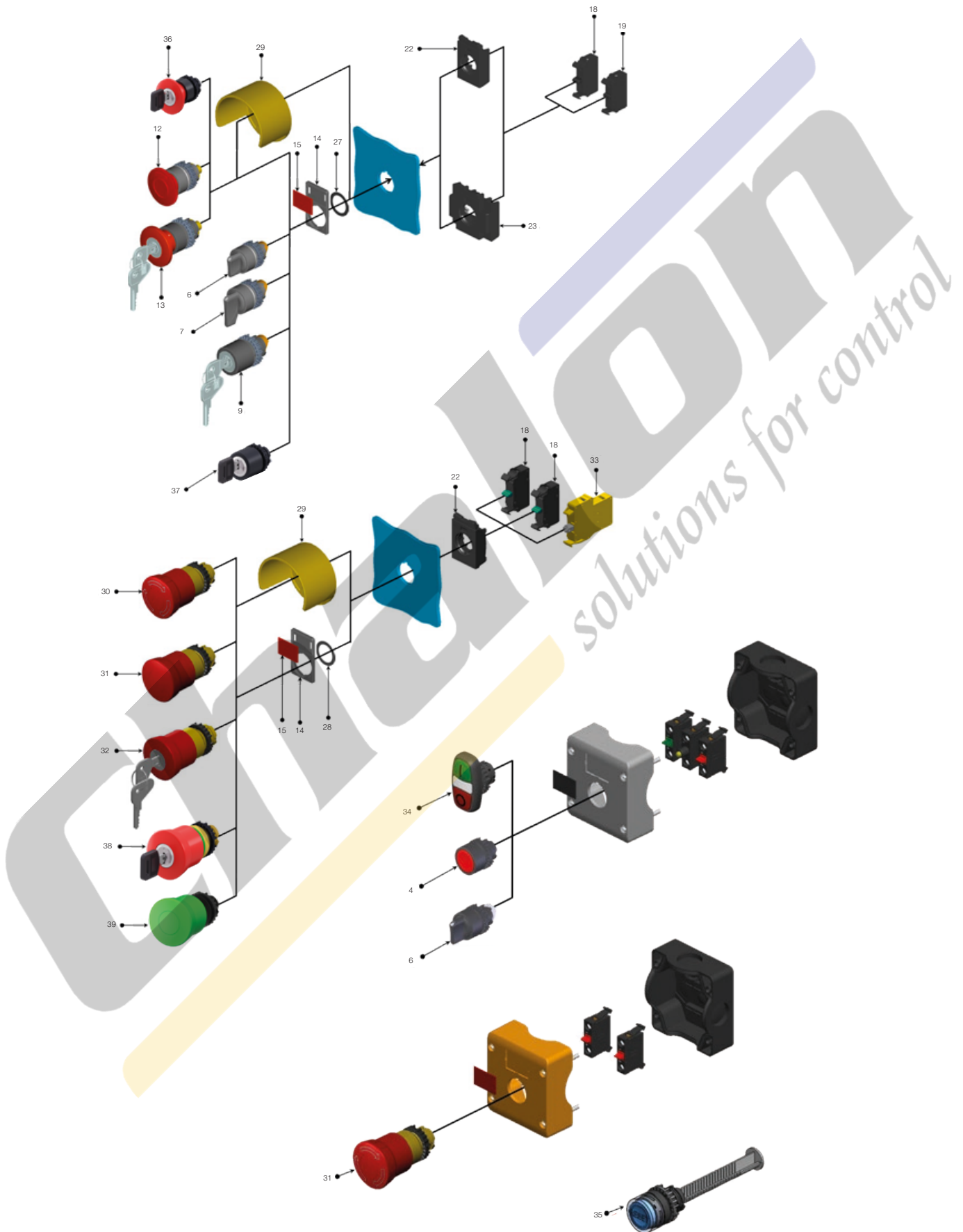

Pushbuttons - Non-Illuminated - Ø22 mm - IP66

Supply: Frontal Part Only

Flush

Illustrative image	Color		Reference	Code	Weight (kg)
		White	CSW-BF0 WH	12880559	0.021
		Red	CSW-BF1 WH	12881927	
		Green	CSW-BF2 WH	12882149	
		Yellow	CSW-BF3 WH	12882150	
		Blue	CSW-BF4 WH	12882151	
		Black	CSW-BF5 WH	12882152	

Guarded

Illustrative image	Color		Reference	Code	Weight (kg)
		White	CSW-BGA0 WH	12882154	0.022
		Red	CSW-BGA1 WH	12882155	
		Green	CSW-BGA2 WH	12882156	
		Yellow	CSW-BGA3 WH	12882157	
		Blue	CSW-BGA4 WH	12882158	
		Black	CSW-BGA5 WH	12882159	

Extended¹⁾

Illustrative image	Color		Reference	Code	Weight (kg)
		White	CSW-BS0 WH	12882167	0.021
		Red	CSW-BS1 WH	12882208	
		Green	CSW-BS2 WH	12882210	
		Yellow	CSW-BS3 WH	12882211	
		Blue	CSW-BS4 WH	12882212	
		Black	CSW-BS5 WH	12882213	

Mushroom - External Diameter: 40 mm¹⁾

Illustrative image	Color		Reference	Code	Weight (kg)
		White	CSW-BC0 WH	12882160	0.024
		Red	CSW-BC1 WH	12882161	
		Green	CSW-BC2 WH	12882162	
		Yellow	CSW-BC3 WH	12882163	
		Blue	CSW-BC4 WH	12882164	
		Black	CSW-BC5 WH	12882166	

Mushroom - External Diameter: Ø42 mm for Heavy Duty (Heavy Duty)

Illustrative image	Color		Reference	Code	Weight (kg)
		Red	CSW-BCHD1-WH	14571710	0.049
		Green	CSW-BCHD2-WH	14571712	

How to Order²⁾

- Frontal part
- + Flange
- + Contact block

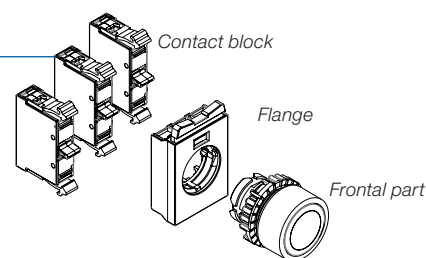



















Notes: 1) They do not allow the use of contact blocks in the center of the flange.

2) Check the maximum number of contact blocks recommended for each frontal part on page 53.















Pushbuttons - Non-Illuminated - Ø22 mm - IP66

Supply: Frontal Part Only

Flush Double Pushbutton¹⁾

Illustrative image	Frontal part	Color	Engraving	Reference	Code	Weight (kg)
	Flush		Green	I	CSW2-BDF21IO WH	12724261
	Flush		Red	0		
	Flush		Green	START	CSW2-BDF21LD WH	12914942
	Flush		Red	STOP		
	Flush		Green	START	CSW2-BDF21SS WH	12905152
	Flush		Red	STOP		
	Flush		Green	No engraving	CSW2-BDF21 WH	12905153
	Flush		Red	No engraving		
	Flush		White	I	CSW2-BDF05IO WH	12905154
	Flush		Black	0		
	Flush		White	START	CSW2-BDF05SS WH	12905156
	Flush		Black	STOP		
	Flush		White	No engraving	CSW2-BDF05 WH	12905157
	Flush		Black	No engraving		
	Flush		Black	+	CSW2-BDF55PN WH	12905179
	Flush		Black	-		
Flush		Black	↑	CSW2-BDF55FR WH	12905181	
Flush		Black	↓			

Extended Double Pushbutton¹⁾

Illustrative image	Frontal part	Color	Engraving	Reference	Code	Weight (kg)
	Flush		Green	I	CSW2-BDS21IO WH	12724178
	Extended		Red	0		
	Flush		Green	START	CSW2-BDS21LD WH	12914944
	Extended		Red	STOP		
	Flush		Green	START	CSW2-BDS21SS WH	12905187
	Extended		Red	STOP		
	Flush		Green	No engraving	CSW2-BDS21 WH	12905208
	Extended		Red	No engraving		
	Flush		White	I	CSW2-BDS05IO WH	12905209
	Extended		Black	0		
	Flush		White	START	CSW2-BDS05SS WH	12905210
	Extended		Black	STOP		
	Flush		White	No engraving	CSW2-BDS05 WH	12905211
	Extended		Black	No engraving		

How to Order²⁾

- Frontal part
- + Flange
- + Contact block

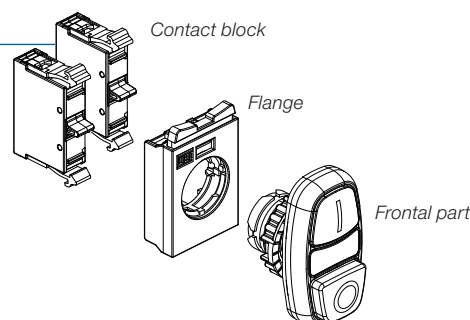

















Notes: 1) They do not allow the use of contact blocks in the center of the flange.
 2) Check the maximum number of contact blocks recommended for each frontal part on page 53.















Pushbuttons - Non-Illuminated - Ø22 mm - IP66

Supply: Frontal Part Only

Flush Double Pushbutton with Silver Bezel¹⁾

Illustrative image	Frontal part	Color	Engraving	Reference	Code	Weight (kg)
	Flush		Green	I	CSW2-BDFC21IO WH	13184929
	Flush		Red	0		
	Flush		Green	START	CSW2-BDFC21LD WH	13184931
	Flush		Red	STOP		
	Flush		Green	START	CSW2-BDFC21SS WH	13184932
	Flush		Red	STOP		
	Flush		Green	No engraving	CSW2-BDFC21 WH	13184933
	Flush		Red	No engraving		
	Flush		White	I	CSW2-BDFC05IO WH	13184934
	Flush		Black	0		
	Flush		White	START	CSW2-BDFC05SS WH	13184936
	Flush		Black	STOP		
	Flush		White	No engraving	CSW2-BDFC05 WH	13184937
	Flush		Black	No engraving		
	Flush		Black	+	CSW2-BDFC55PN WH	13184988
	Flush		Black	-		
Flush		Black	↑	CSW2-BDFC55FR WH	13184989	
Flush		Black	↓			

Double Extended Pushbutton with Silver Bezel¹⁾

Illustrative image	Frontal part	Color	Engraving	Reference	Code	Weight (kg)
	Flush		Green	I	CSW2-BDSC21 WH	13184993
	Extended		Red	0		
	Flush		Green	START	CSW2-BDSC21LD WH	13184991
	Extended		Red	STOP		
	Flush		Green	START	CSW2-BDSC21IO WH	13184990
	Extended		Red	STOP		
	Flush		Green	No engraving	CSW2-BDSC21 WH	13184993
	Extended		Red	No engraving		
	Flush		White	I	CSW2-BDSC05IO WH	13184994
	Extended		Black	0		
	Flush		White	START	CSW2-BDSC05SS WH	13184995
	Extended		Black	STOP		
	Flush		White	No engraving	CSW2-BDSC05 WH	13184996
	Extended		Black	No engraving		

How to Order²⁾

- Frontal part
- + Flange
- + Contact block

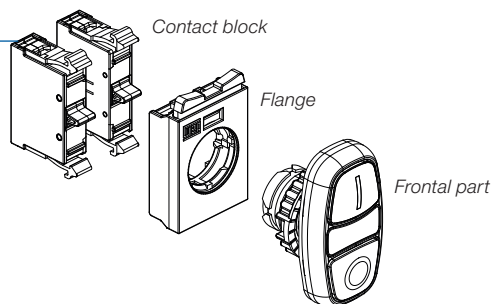

Notes: 1) They do not allow the use of contact blocks in the center of the flange.
 2) Check the maximum number of contact blocks recommended for each frontal part on page 53.

Pushbuttons - Non-Illuminated - Ø22 mm - IP66

Supply: Frontal Part Only Flush

Triple Pushbutton¹⁾

Illustrative image	Frontal part	Color	Engraving	Reference	Code	Weight (kg)
	Flush	Green		CSW2-BTF212IIS WH	13120276	0.034
	Extended	Red	STOP			
	Flush	Green	0			
	Flush	Green	→			
	Extended	Red	STOP	CSW2-BTF212RLS WH	13120358	
	Flush	Green	←			
	Flush	Green	↑	CSW2-BTF212FRS WH	13120359	
	Extended	Red	STOP			
	Flush	Green	↓	CSW2-BTF515FRS WH	13120360	
	Extended	Red	STOP			
	Flush	Black	↑	CSW2-BTF515FRD WH	13120361	
	Extended	Red	STOP			
	Flush	Black	↓	CSW2-BTF015FRS WH	13120362	
	Extended	Red	STOP			
	Flush	Black	↓	CSW2-BTF015RLS WH	13120365	
	Extended	Red	STOP			
	Flush	Black	←	CSW2-BTF212PNS WH	13120366	
	Extended	Red	STOP			
	Flush	Green	+	CSW2-BTF515PNS WH	13120367	
	Extended	Red	STOP			
	Flush	Black	+	CSW2-BTF515PND WH	13120410	
	Extended	Red	STOP			
	Flush	Black	-	CSW2-BTF24110RM WH	13120411	
	Extended	Red	0			
	Flush	Green		CSW2-BTF24110R WH	13120530	
	Extended	Blue	RESET			
	Flush	Red	0	CSW2-BTF045IOR WH	13120531	
	Extended	Blue	RESET			
	Flush	White		CSW2-BTF045SSR WH	13120532	
	Extended	Blue	RESET			
	Flush	Black	STOP	CSW2-BTF241LDRM WH	13120533	
	Flush	Green	START			
	Extended	Blue	RESET	CSW2-BTF241LDR WH	13120534	
	Flush	Red	STOP			

How to Order²⁾

- Frontal part
- + Flange
- + Contact block

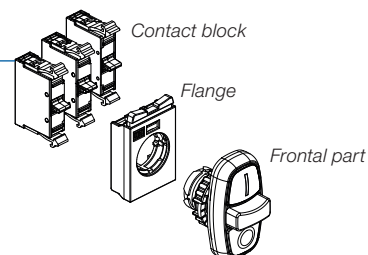

Notes: 1) Other colors and functions on request.

2) Check the maximum number of contact blocks recommended for each frontal part on page 53.

Pushbuttons - Non-Illuminated - Ø22 mm - IP66

Supply: Frontal Part Only

Flush Triple Pushbutton with Silver Bezel¹⁾

Illustrative image	Frontal part	Color	Engraving	Reference	Code	Weight (kg)	
	Flush	Green	I	CSW2-BTFC212IIS WH	13185098	0.034	
	Extended	Red	STOP				
	Flush	Green	II	CSW2-BTFC212RLS WH	13185099		
	Flush	Green	→				
	Extended	Red	STOP	CSW2-BTFC212FRS WH	13185100		
	Flush	Green	←				
	Flush	Green	↑	CSW2-BTFC515FRS WH	13185102		
	Extended	Red	STOP				
	Flush	Green	↓	CSW2-BTFC515FRD WH	13185105		
	Flush	Black	↑				
	Extended	Red	STOP	CSW2-BTFC015FRS WH	13185107		
	Flush	Black	↓				
	Flush	White	↑	CSW2-BTFC015RLS WH	13185158		
	Extended	Red	STOP				
	Flush	Black	↓	CSW2-BTFC212PNS WH	13185160		
	Flush	Green	+				
	Extended	Red	STOP	CSW2-BTFC515PNS WH	13185162		
	Flush	Green	-				
	Flush	Black	+	CSW2-BTFC515PND WH	13185163		
	Extended	Red	STOP				
	Flush	Black	-	CSW2-BTFC241IORM WH	13185164		
	Flush	Green	I				
	Extended	Blue	RESET	CSW2-BTFC241IOR WH	13185165		
	Flush	Red	O				
	Flush	Green	I	CSW2-BTFC045IOR WH	13185167		
	Extended	Blue	RESET				
	Flush	Black	O	CSW2-BTFC045SSR WH	13185239		
	Flush	White	START				
	Extended	Blue	RESET	CSW2-BTFC241LDRM WH	13185241		
	Flush	Black	STOP				
	Flush	Green	START	CSW2-BTFC241LDR WH	13185242		
	Extended	Blue	RESET				
	Flush	Red	STOP				

How to Order²⁾

- Frontal part
- + Flange
- + Contact block

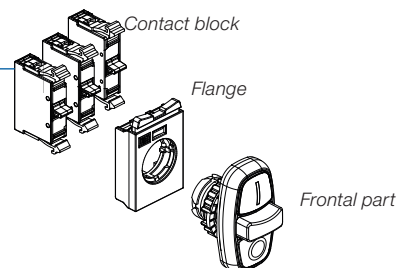





Notes: 1) They do not allow the use of contact blocks in the center of the flange.
 2) Check the maximum number of contact blocks recommended for each frontal part on page 53.





Pushbuttons - Non-Illuminated - Ø22 mm - IP66

Supply: Frontal Part Only

Extended Triple Pushbutton¹⁾

Illustrative image	Frontal part	Color	Engraving	Reference	Code	Weight (kg)
	Flush		Green	I	CSW2-BTS241IORM WH	13120536
	Extended		Blue	RESET		
	Extended		Red	0		
	Flush		Green	I	CSW2-BTS241IOR WH	13120537
	Extended		Blue	RESET		
	Extended		Red	0		
	Flush		Green	START	CSW2-BTS241LDRM WH	13120559
	Extended		Blue	RESET		
	Extended		Red	STOP		
	Flush		Green	START	CSW2-BTS241LDR WH	13120561
	Extended		Blue	RESET		
	Extended		Red	STOP		

Triple Extended with Silver Bezel¹⁾

Illustrative image	Frontal part	Color	Engraving	Reference	Code	Weight (kg)
	Flush		Green	I	CSW2-BTSC241IORM WH	13185244
	Extended		Blue	RESET		
	Extended		Red	0		
	Flush		Green	I	CSW2-BTSC241IOR WH	13185245
	Extended		Blue	RESET		
	Extended		Red	0		
	Flush		Green	START	CSW2-BTSC241LDRM WH	13185246
	Extended		Blue	RESET		
	Extended		Red	STOP		
	Flush		Green	START	CSW2-BTSC241LDR WH	13185247
	Extended		Blue	RESET		
	Extended		Red	STOP		

How to Order²⁾

- Frontal part
- + Flange
- + Contact block

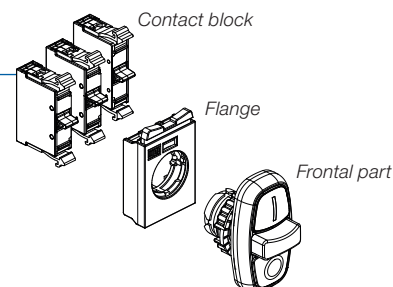

Notes: 1) Other colors and functions on request.

2) Check the maximum number of contact blocks recommended for each frontal part on page 53.

Pushbuttons with Latch - Non-Illuminated - Ø22 mm - IP66

Supply: Frontal Part Only

Emergency Stop - ISO 13850 (EN 418) and IEC 60947-5-5 - External Diameter: 42 mm

Illustrative image	Description	Signaling	Color		Reference	Code	Weight (kg)
	Pull-to-release	-		Red	CSW-BESP WH	12882459	0.049
	Twist-to-release	-		Red	CSW-BESG WH	12882447	
	Yale key release ¹⁾	-		Red	CSW-BESY WH	12882461	0.114
	455 key release	-		Red	CSW-BESW WH	15687773	0.114
	Pull-to-release	Side		Red	CSW-BESPS WH	12882463	0.049
	Twist-to-release	Side		Red	CSW-BESGS WH	12882462	
	Yale key release ¹⁾	Side		Red	CSW-BESYS WH	12882464	0.114
	455 key release	Side		Red	CSW-BESWS WH	15687774	0.114
	Pull-to-release with round engraving EMERGENCY	-		Red	CSW-BESP48 WH	12932074	0.049
	Twist-to-release with round engraving EMERGENCY	-		Red	CSW-BESG46 WH	13034654	
	Pull-to-release with round engraving EMERGENCY	Side		Red	CSW-BESPS48 WH	13553037	

How to Order²⁾

- Frontal part
- + Flange
- + Contact block

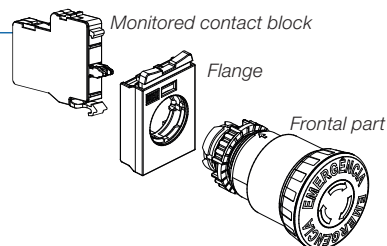













Notes: 1) Other colors and functions on request.

2) Check the maximum number of contact blocks recommended for each frontal part on page 53.

Pushbuttons with Latch - Non-Illuminated - Ø22 mm - IP66

Supply: Frontal Part Only

Monitored Emergency Stop - ISO 13850 (EN 418) and IEC 60947-5-5 - External Diameter: 42 mm

Illustrative image	Description	Signaling	Color		Reference	Code	Weight (kg)
	Pull-to-release	-		Red	CSW-BESPM WH	13268409	0.049
	Twist-to-release	-		Red	CSW-BESGM WH	13268381	
	Yale key release ¹⁾	-		Red	CSW-BESYM WH	13274097	0.114
	455 key release	-		Red	CSW-BESWM WH	15687775	0.114
	Pull-to-release	Side		Red	CSW-BESPSM WH	13277427	0.049
	Twist-to-release	Side		Red	CSW-BESGSM WH	13277423	
	Com chave ¹⁾	Side		Red	CSW-BESYSM WH	13277425	0.114

How to Order²⁾

- Frontal part
- + Flange
- + Contact block

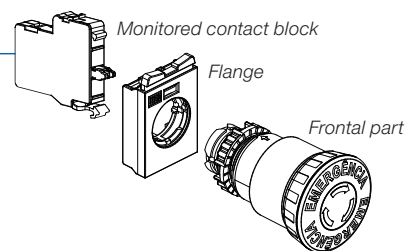





Notes: 1) Keys with different combinations on request only.
 2) Check the maximum number of contact blocks recommended for each frontal part on page 53.

Pushbuttons with Latch and Front Signaling - Ø22 mm - IP66

Supply: Frontal Part Only

Emergency Stop - ISO 13850 (EN 418) and IEC 60947-5-5 - External Diameter: 42 mm

Illustrative image	Description	Signaling		Color		Reference	Code	Weight (kg)
		Front	Side					
	Pull-to-release	Mechanical			Red	CSW-BESPF-WH	14665833	0.048
	Twist-to-release				Red	CSW-BESGF-WH	14665775	
	Pull-to-release	Lighting			Red	CSW-BESPF-I-WH	15730752	0.045
	Twist-to-release				Red	CSW-BESGF-I-WH	15730750	
	Pull-to-release	Mechanical			Red	CSW-BESPF-WH	16525739	0.048
	Twist-to-release				Red	CSW-BESGF-WH	16525604	
	Pull-to-release	Lighting	Yes		Red	CSW-BESPSFI-WH	15730888	0.045
	Twist-to-release			Red	CSW-BESGSFI-WH	15730753		

How to Order²⁾

- Frontal part
- + Flange
- + Contact block

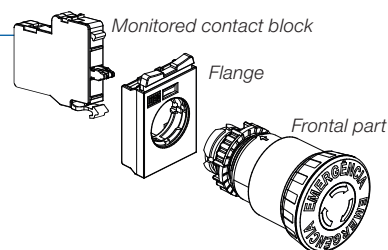

Notes: 1) Keys with different combinations on request only.

2) Check the maximum number of contact blocks recommended for each frontal part on page 53.

Pushbuttons with Latch and Front Signaling - Ø22 mm - IP66

Supply: Frontal Part Only

Monitored Emergency Stop - ISO 13850 (EN 418) and IEC 60947-5-5 - External Diameter: 42 mm

Illustrative image	Description	Signaling		Color		Reference	Code	Weight (kg)
		Front	Side					
	Pull-to-release	Mechanical			Red	CSW-BESPFM-WH	14665837	0.048
	Twist-to-release				Red	CSW-BESGFM-WH	14665807	
	Pull-to-release	Lighting			Red	CSW-BESPFM-WH	15730895	0.045
	Twist-to-release				Red	CSW-BESGFM-WH	15730892	
	Pull-to-release	Mechanical			Red	CSW-BESPSFM-WH	16525740	0.048
	Twist-to-release				Red	CSW-BESGSFM-WH	16525738	
	Pull-to-release	Lighting	Yes		Red	CSW-BESPSFIM-WH	15730938	0.045
	Twist-to-release				Red	CSW-BESGSFIM-WH	15730896	

How to Order²⁾

- Frontal part
- + Flange
- + Contact block

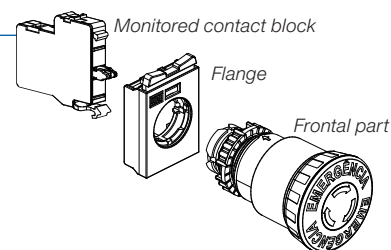

Notes: 1) Keys with different combinations on request only.
 2) Check the maximum number of contact blocks recommended for each frontal part on page 53.

Pushbuttons with Latch - Non-Illuminated - Ø22 mm - IP66

Supply: Frontal Part Only

Mushroom Twist-to-Release - External Diameter: 40 mm¹⁾

Illustrative image	Color	Reference	Code	Weight (kg)
		White	CSW-BCT0 WH	12882214
		Red	CSW-BCT1 WH	12882215
		Green	CSW-BCT2 WH	12882216
		Yellow	CSW-BCT3 WH	12882217
		Blue	CSW-BCT4 WH	12882249
		Black	CSW-BCT5 WH	12882250

0.027

Mushroom with Yale Key - External Diameter: 40 mm¹⁾

Illustrative image	Color	Reference	Code	Weight (kg)
		White	CSW-BCY0 WH	12882251
		Red	CSW-BCY1 WH	12882252
		Green	CSW-BCY2 WH	12882253
		Yellow	CSW-BCY3 WH	12882255
		Blue	CSW-BCY4 WH	12882256
		Black	CSW-BCY5 WH	12882257

0.090

Mushroom with Yale Key - External Diameter: 40 mm¹⁾

Illustrative image	Color	Reference	Code	Weight (kg)
		White	CSW-BCW0 WH	15722013
		Red	CSW-BCW1 WH	15687898
		Green	CSW-BCW2 WH	15687899
		Yellow	CSW-BCW3 WH	15722010
		Blue	CSW-BCW4 WH	15722011
		Black	CSW-BCW5 WH	15722012

0.090

How to Order²⁾

- Frontal part
- + Flange
- + Contact block

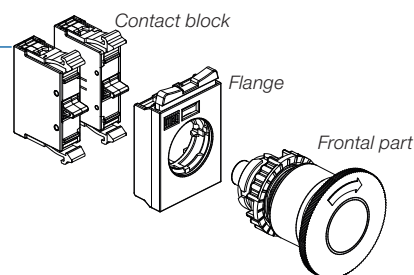

Notes: 1) They do not allow the use of contact blocks in the center of the flange.

2) Check the maximum number of contact blocks recommended for each frontal part on page 53.

Pushbuttons - Illuminated - Ø22 mm - IP66

Supply: Frontal Part Only







Flush¹⁾²⁾

Illustrative image	Color	Reference	Code	Weight (kg)
		White	CSW-BF10 WH	12882258
		Red	CSW-BF11 WH	12882259
		Green	CSW-BF12 WH	12882260
		Yellow	CSW-BF13 WH	12882261
		Blue	CSW-BF14 WH	12882262
		Orange	CSW-BF16 WH ³⁾	12882264

Saliente¹⁾²⁾

Illustrative image	Color	Reference	Code	Weight (kg)
		White	CSW-BS10 WH	12882265
		Red	CSW-BS11 WH	12882266
		Green	CSW-BS12 WH	12882267
		Yellow	CSW-BS13 WH	12882298
		Blue	CSW-BS14 WH	12882299
		Orange	CSW-BS16 WH ³⁾	12882300

Mushroom - External Diameter: Ø40 mm¹⁾²⁾

Illustrative image	Color	Reference	Code	Weight (kg)
		White	CSW-BC10 WH	12882301
		Red	CSW-BC11 WH	12882302
		Green	CSW-BC12 WH	12882303
		Yellow	CSW-BC13 WH	12882304
		Blue	CSW-BC14 WH	12882305
		Orange	CSW-BC16 WH ³⁾	12882306

How to Order⁴⁾

- Frontal part
- + Flange
- + Contact block
- + Illumination block

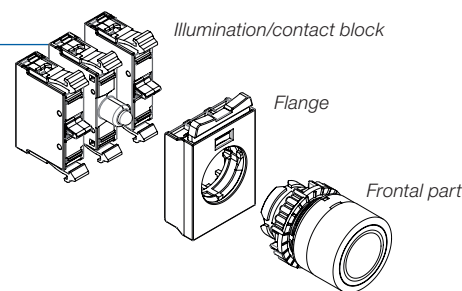











Notes: 1) They do not allow the use of contact blocks in the center of the flange.
 2) It allows the use of illumination contact block in the center of the flange.
 3) For a better performance, use a yellow LED block.
 4) Check the maximum number of contact blocks recommended for each frontal part on page 53.









Pushbuttons - Illuminated - Ø22 mm - IP66

Supply: Frontal Part Only

Flush Double Pushbutton¹⁾²⁾³⁾

Illustrative image	Frontal part	Color	Engraving	Reference	Code	Weight (kg)
	Flush		Green	I	CSW2-BDFI2110 WH	12756258
	Flush		Red	O		
	Flush		Green	START	CSW2-BDFI211LD WH	12914943
	Flush		Red	STOP		
	Flush		Green	START	CSW2-BDFI21SS WH	12904803
	Flush		Red	STOP		
	Flush		Green	No engraving	CSW2-BDFI21 WH	12904818
	Flush		Red	No engraving		
	Flush		White	I	CSW2-BDFI0510 WH	12904819
	Flush		Black	O		
	Flush		White	START	CSW2-BDFI05SS WH	12904822
	Flush		Black	STOP		
	Flush		White	No engraving	CSW2-BDFI05 WH	12904824
	Flush		Black	No engraving		
	Flush		Black	+	CSW2-BDFI55PN WH	12904825
	Flush		Black	-		
Flush		Black	↑	CSW2-BDFI55FR WH	12904827	
Flush		Black	↓			

Extended Double Pushbutton¹⁾²⁾³⁾

Illustrative image	Frontal part	Color	Engraving	Reference	Code	Weight (kg)
	Flush		Green	I	CSW2-BDSI2110 WH	12904828
	Extended		Red	O		
	Flush		Green	START	CSW2-BDSI211LD WH	12914946
	Extended		Red	STOP		
	Flush		Green	START	CSW2-BDSI21SS WH	12904831
	Extended		Red	STOP		
	Flush		Green	No engraving	CSW2-BDSI21 WH	12904834
	Extended		Red	No engraving		
	Flush		White	I	CSW2-BDSI0510 WH	12904837
	Extended		Black	O		
	Flush		White	START	CSW2-BDSI05SS WH	12904848
	Extended		Black	STOP		
	Flush		White	No engraving	CSW2-BDSI05 WH	12904850
	Extended		Black	No engraving		

How to Order⁴⁾

- Frontal part
- + Flange
- + Contact block
- + Illumination block

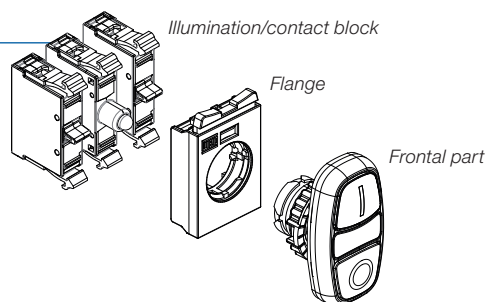



















Notes: 1) They do not allow the use of contact blocks in the center of the flange.
 2) It allows the use of illumination contact block in the center of the flange.
 3) It allows illumination by means of LED block.
 4) Check maximum number of illumination/contact blocks recommended for each frontal part on page 53.















Pushbuttons - Illuminated - Ø22 mm - IP66

Supply: Frontal Part Only

Flush Double Pushbutton with Silver Bezel¹⁾²⁾³⁾

Illustrative image	Frontal part	Color	Engraving	Reference	Code	Weight (kg)
	Flush		Green	I	CSW2-BDFIC2110 WH	13185008
	Flush		Red	0		
	Flush		Green	START	CSW2-BDFIC21LD WH	13185010
	Flush		Red	STOP		
	Flush		Green	START	CSW2-BDFIC21SS WH	13185011
	Flush		Red	STOP		
	Flush		Green	No engraving	CSW2-BDFIC21 WH	13185012
	Flush		Red	No engraving		
	Flush		White	I	CSW2-BDFIC0510 WH	13185013
	Flush		Black	0		
	Flush		White	START	CSW2-BDFIC05SS WH	13185014
	Flush		Black	STOP		
	Flush		White	No engraving	CSW2-BDFIC05 WH	13185015
	Flush		Black	No engraving		
	Flush		Black	+	CSW2-BDFIC55PN WH	13185016
	Flush		Black	-		
Flush		Black	↑	CSW2-BDFIC55FR WH	13185017	
Flush		Black	↓			

Double Extended Pushbutton with Silver Bezel¹⁾²⁾³⁾

Illustrative image	Frontal part	Color	Engraving	Reference	Code	Weight (kg)
	Flush		Green	I	CSW2-BDSIC2110 WH	13185059
	Extended		Red	0		
	Flush		Green	START	CSW2-BDSIC21LD WH	13185060
	Extended		Red	STOP		
	Flush		Green	START	CSW2-BDSIC21SS WH	13185061
	Extended		Red	STOP		
	Flush		Green	No engraving	CSW2-BDSIC21 WH	13185062
	Extended		Red	No engraving		
	Flush		White	I	CSW2-BDSIC0510 WH	13185063
	Extended		Black	0		
	Flush		White	START	CSW2-BDSIC05SS WH	13185065
	Extended		Black	STOP		
	Flush		White	No engraving	CSW2-BDSIC05 WH	13185067
	Extended		Black	No engraving		

How to Order⁴⁾

- Frontal part
- + Flange
- + Contact block
- + Illumination block

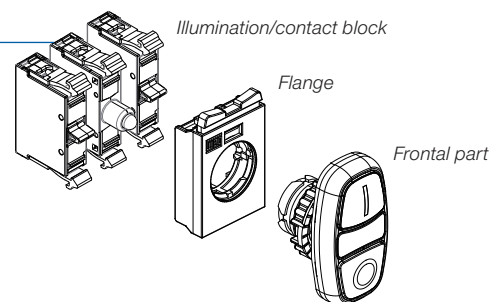

Notes: 1) They do not allow the use of contact blocks in the center of the flange.
 2) It allows the use of illumination contact block in the center of the flange.
 3) It allows illumination by means of LED block.
 4) Check maximum number of illumination/contact blocks recommended for each frontal part on page 53.

Pushbuttons - Illuminated - Ø22 mm - IP52

Supply: Frontal Part Only

Double Flush Pushbutton - IP52 Protection Rating¹⁾²⁾³⁾

Illustrative image	Color	Engraving	Reference	Code	Weight (kg)
		Green	I	CSW-BD WH	12884105
		Red	O		
		Green	START	CSW-BD21LD WH	12924756
		Red	STOP		
		Green	START	CSW-BD21SS WH	12884106
		Red	STOP		
		Green	No engraving	CSW-BD21 WH	12884108
		Red	No engraving		
		White	I	CSW-BD05IO WH	12884109
		Black	O		
		White	START	CSW-BD05SS WH	12884110
		Black	STOP		
		White	No engraving	CSW-BD05 WH	12884112
		Black	No engraving		
	Black	+	CSW-BD55PN WH	12884114	
	Black	-			
	Black	↑	CSW-BD55FR WH	12884115	
	Black	↓			

How to Order

- Frontal part
- + Flange
- + Contact block
- + Illumination block

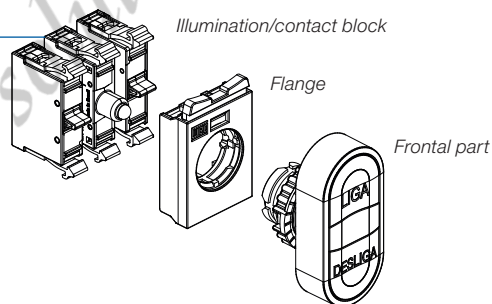

Pilot Lights - Ø22 mm - IP66

Supply: Frontal Part Only

Diffuse¹⁾²⁾

Illustrative image	Color	Reference	Code	Weight (kg)
		White	CSW-SD0 WH	0.016
		Red	CSW-SD1 WH	
		Green	CSW-SD2 WH	
		Yellow	CSW-SD3 WH	
		Blue	CSW-SD4 WH	
		Orange	CSW-SD6 WH ⁴⁾	

How to Order⁵⁾

- Frontal part
- + Flange
- + Contact block
- + Illumination block

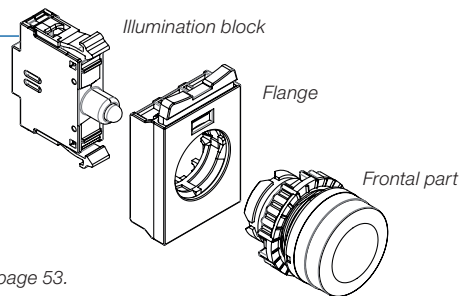

Notes: 1) It allows illumination by means of LED block.

2) It does not allow the use of contact blocks in the center of the flange.

3) In order to increase the protection rating to IP66, use the APBD accessory.





4) For a better performance, use a yellow LED block.

5) Check maximum number of illumination/contact blocks recommended for each frontal part on page 53.





2-Position Selector Switches - Non-Illuminated - Ø22 mm - IP66

Supply: Frontal Part Only

Knob¹⁾

Illustrative image	Position	Diagram	Selector angle	Color ¹⁾		Reference	Code	Weight (kg)	
		Maintained	1	45°	●	Black	CSW-CK2F45 WH	12882307	0.025
		Momentary	1	45°	●	Black	CSW-CK2R45 WH	12882309	
		Maintained	1	90°	●	Black	CSW-CK2F90 WH	12882308	
			2	90°	●	Black	CSW-CK2F90W WH	12904656	
		Momentary	1	90°	●	Black	CSW-CK2R90 WH	12882310	

Lever¹⁾

Illustrative image	Position	Diagram	Selector angle	Color ¹⁾		Reference	Code	Weight (kg)	
		Maintained	1	45°	●	Black	CSW-CA2F45 WH	12882316	0.025
		Momentary	1	45°	●	Black	CSW-CA2R45 WH	12882338	
		Maintained	1	90°	●	Black	CSW-CA2F90 WH	12882317	
			2	90°	●	Black	CSW-CA2F90W WH	12904688	
		Momentary	1	90°	●	Black	CSW-CA2R90 WH	12882339	

With Yale Key Release²⁾³⁾































Illustrative image	Position	Diagram	Selector angle	Color ¹⁾		Reference	Code	Weight (kg)	
		Maintained	1	45°	●	Black	CSW-CY2F45 WH	12882344	0.087
		Momentary	1	45°	●	Black	CSW-CY2R45 WH	12882346	
		Maintained	1	90°	●	Black	CSW-CY2F90 WH	12882369	
			2	90°	●	Black	CSW-CY2F90W WH	12904689	
		Momentary	1	90°	●	Black	CSW-CY2R90 WH	12882370	

Diagram 1				Diagram 2				Flanges				
Position of the selector switch	Contactor position on the flange				Position of the selector switch	Contactor position on the flange						
		-	2	3		1	-		-	2	3	1
	4	2	5	1	3	4	2		5	1	3	5P
0						0						
I						I						

Legend

-  Contacts in the rest position.
-  Contacts operated.

How to Order⁴⁾

- Frontal part
- + Flange
- + Contact block

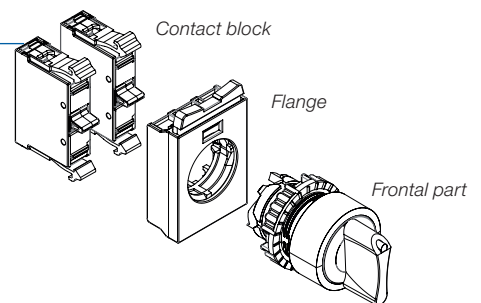

Notes: 1) Selector switches in other colors, on request only.

2) Keys with different combinations only on request.

3) Key is released in any position. For key release in specific positions, replace CY by: CYD (only on the right), CYE (only on the left) and CYC (only in the center).

4) Check the maximum number of contact blocks recommended for each frontal part on page 53.

2-Position Selector Switches - Non-Illuminated - Ø22 mm - IP66

Supply: Frontal Part Only

With Standard 455 Key









Illustrative image	Position		Diagram	Selector angle	Color ¹⁾		Reference	Code	Weight (kg)
	Symbol	Description			Color	Material			
		Maintained	1	45°	All	●	Black	CSW-CW2F45 WH	15686689
		Momentary	1	45°	All	●	Black	CSW-CW2R45 WH	15686690
		Maintained	1	90°	All	●	Black	CSW-CW2F90 WH	15686692
		Momentary	1	90°	All	●	Black	CSW-CW2R90 WH	15686693
		Maintained	1	45°	All	●	Black	CSW-CWC2F45 WH	15685836
		Maintained	1	45°	Right	●	Black	CSW-CWD2F45 WH	15686663
		Maintained	1	90°	Right	●	Black	CSW-CWD2F90 WH	15686667
		Maintained	1	90°	Left	●	Black	CSW-CWE2F90 WH	15685894

Diagram 1					Diagram 2					Flanges	
Position of the selector switch	Contactors position on the flange				Position of the selector switch	Contactors position on the flange					
		-	2	3		1	-	-	2	3	1
4		2	5	1	3	4	2	5	1	3	5P
0	<input type="checkbox"/>	<input type="checkbox"/>	<input type="checkbox"/>	<input type="checkbox"/>	<input type="checkbox"/>	0	<input checked="" type="checkbox"/>	<input checked="" type="checkbox"/>	<input type="checkbox"/>	<input type="checkbox"/>	
I	<input checked="" type="checkbox"/>	<input checked="" type="checkbox"/>	<input type="checkbox"/>	<input checked="" type="checkbox"/>	<input checked="" type="checkbox"/>	I	<input type="checkbox"/>	<input type="checkbox"/>	<input checked="" type="checkbox"/>	<input checked="" type="checkbox"/>	

Legend

- Contacts in the rest position.
- Contacts operated.

How to Order⁴⁾

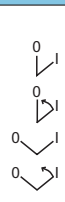
- Frontal part
- + Flange
- + Contact block

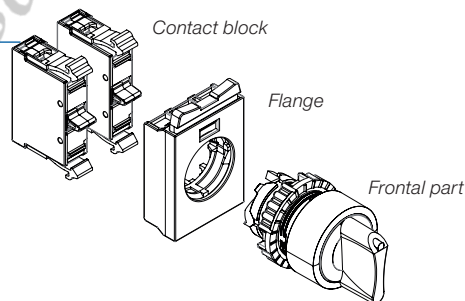





Notes: 1) Selector switches in other colors, on request only.
 2) Keys with different combinations only on request.
 3) Key is released in any position. For key release in specific positions, replace CY by: CYD (only on the right), CYE (only on the left) and CYC (only in the center).
 4) Check the maximum number of contact blocks recommended for each frontal part on page 53.





3-Position Selector Switches - Non-Illuminated - Ø22 mm - IP66

Supply: Frontal Part Only

Knob¹⁾

Illustrative image	Position	Diagram	Selector angle	Color ¹⁾		Reference	Code	Weight (kg)	
	 I	Maintained	1	45°	●	Black	CSW-CK3F45 WH	12882311	0.025
	 0	Momentary	1	45°	●	Black	CSW-CK3R45 WH	12882312	
	 II	Momentary on the right	1	45°	●	Black	CSW-CK3RD45 WH	12882315	
	 I	Momentary on the left	1	45°	●	Black	CSW-CK3RE45 WH	12882314	

Lever¹⁾

Illustrative image	Position	Diagram	Selector angle	Color ¹⁾		Reference	Code	Weight (kg)	
	 I	Maintained	1	45°	●	Black	CSW-CA3F45 WH	12882340	0.025
	 0	Momentary	1	45°	●	Black	CSW-CA3R45 WH	12882341	
	 II	Momentary on the right	1	45°	●	Black	CSW-CA3RD45 WH	12882343	
	 I	Momentary on the left	1	45°	●	Black	CSW-CA3RE45 WH	12882342	

Key Release²⁾³⁾











Illustrative image	Position	Diagram	Selector angle	Color ¹⁾		Reference	Code	Weight (kg)	
	 I	Maintained	1	45°	●	Black	CSW-CY3F45 WH	12882347	0.087
	 0	Momentary	1	45°	●	Black	CSW-CY3R45 WH	12882368	
	 II	Momentary on the right	1	45°	●	Black	CSW-CY3RD45 WH	12882373	
	 I	Momentary on the left	1	45°	●	Black	CSW-CY3RE45 WH	12882372	

Diagram 1			Flanges				
Position of selector	Contactor position on the flange					3P	
	-	2	3	1	-		
 I							
 0							
 II							

Legend

-  Contacts in the rest position.
-  Contacts operated.

How to Order⁴⁾

- Frontal part
- + Flange
- + Contact block

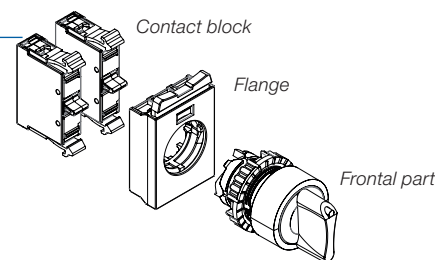









Notes: 1) Selector switches in other colors, on request only.
 2) Keys with different combinations only on request.
 3) Key is released in any position. For key release in specific positions, replace CY by: CYD (only on the right), CYE (only on the left) and CYC (only in the center).
 4) Check the maximum number of contact blocks recommended for each frontal part on page 53.

3-Position Selector Switch - Non-Illuminated - Ø22 mm - IP66

Supply: Frontal Part Only

With Standard 455 Key

Illustrative image	Position		Diagram	Selector angle	Color ¹⁾		Reference	Code	Weight (kg)
		Momentary	1	45°	All	●	Black	CSW-CW3R45 WH	15686691
		Momentary on the right	1	45°	All	●	Black	CSW-CW3RD45 WH	15686695
		Momentary on the left	1	45°	All	●	Black	CSW-CW3RE45 WH	15686694
		Maintained	1	45°	Central	●	Black	CSW-CWC3F45 WH	15685896
		Momentary on the right	1	45°	Central	●	Black	CSW-CWC3RD45 WH	15685948
		Maintained	1	45°	Right	●	Black	CSW-CWD3F45 WH	15686666
		Maintained	1	45°	Left	●	Black	CSW-CWE3F45 WH	15685890
		Maintained	1	45°	Left	●	Black	CSW-CWE3RD45 WH	15685892

0.087

Diagram 1						Flanges
Position of selector	Contactor position on the flange					
		-	2	3	1	-
4		2	5	1	3	5P
I	■	■		□	□	
0	□	□	-	□	□	
II	□	□		■	■	

Legend

- Contacts in the rest position.
- Contacts operated.

How to Order⁴⁾

- Frontal part
- + Flange
- + Contact block

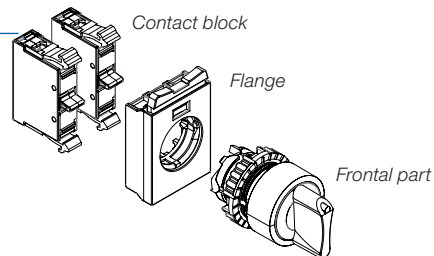

Notes: 1) Selector switches in other colors, on request only.
 2) Keys with different combinations only on request.
 3) Key is released in any position. For key release in specific positions, replace CY by: CYD (only on the right), CYE (only on the left) and CYC (only in the center).
 4) Check the maximum number of contact blocks recommended for each frontal part on page 53.

Selector Switches - Illuminated - Ø22 mm - IP66

Supply: Frontal Part Only

Knob - 2 Positions

Illustrative image	Position		Diagram	Selector angle	Color		Reference	Code	Weight (kg)
	0	I							
	0	I	1	90°	○	White	CSW-CKI2F900 WH	12882374	0.020
					●	Red	CSW-CKI2F901 WH	12882375	
					●	Green	CSW-CKI2F902 WH	12882376	
					●	Yellow	CSW-CKI2F903 WH	12882377	
					●	Blue	CSW-CKI2F904 WH	12882388	
					●	Orange	CSW-CKI2F906 WH ²⁾	12882389	

Knob - 3 Positions

Illustrative image	Position		Diagram	Selector angle	Color		Reference	Code	Weight (kg)
	0	I			II				
	0	I	2	45°	○	White	CSW-CKI3F450 WH	12882391	0.020
					●	Red	CSW-CKI3F451 WH	12882392	
					●	Green	CSW-CKI3F452 WH	12882393	
					●	Yellow	CSW-CKI3F453 WH	12882394	
					●	Blue	CSW-CKI3F454 WH	12882395	
					●	Orange	CSW-CKI3F456 WH ²⁾	12882396	
	0	I	2	45°	○	White	CSW-CKI3R450 WH	12882397	
					●	Red	CSW-CKI3R451 WH	12882408	
					●	Green	CSW-CKI3R452 WH	12882409	
					●	Yellow	CSW-CKI3R453 WH	12882410	
					●	Blue	CSW-CKI3R454 WH	12882411	
					●	Orange	CSW-CKI3R456 WH ²⁾	12882412	
	0	I	2	45°	○	White	CSW-CKI3RD450 WH	12882413	
					●	Red	CSW-CKI3RD451 WH	12882414	
					●	Green	CSW-CKI3RD452 WH	12882415	
					●	Yellow	CSW-CKI3RD453 WH	12882416	
●					Blue	CSW-CKI3RD454 WH	12882417		
●					Orange	CSW-CKI3RD456 WH ²⁾	12882438		
0	I	2	45°	○	White	CSW-CKI3RE450 WH	12882439		
				●	Red	CSW-CKI3RE451 WH	12882440		
				●	Green	CSW-CKI3RE452 WH	12882441		
				●	Yellow	CSW-CKI3RE453 WH	12882442		
				●	Blue	CSW-CKI3RE454 WH	12882443		
				●	Orange	CSW-CKI3RE456 WH ²⁾	12882444		

Diagram 1					Diagram 2					Flanges		
Position of selector	Contactor position on the flange					Position of selector	Contactor position on the flange					
	0	-	2	3	1		-	0	-	2	3	1
I	4	2	5	1	3	I	4	2	5	1	3	5P
0	□	□	□	□	□	0	■	■	□	□	□	
I	■	■	□	■	■	I	□	□	□	□	□	
			☀						☀			
						II	□	□	■	■	■	

Legend

- Contacts in the rest position.
- Contacts operated.
- ☀ Installation position of the illumination blocks on the illuminated selector switches.

How to Order¹⁾

- Frontal part
- + Flange
- + Contact block
- + Illumination block

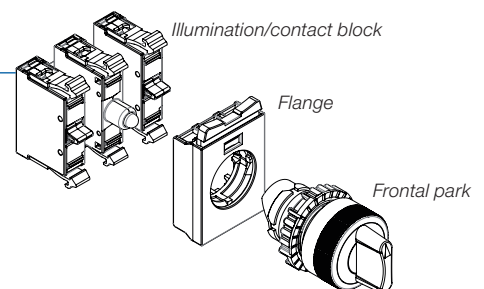



Notes: 1) Check the maximum number of contact blocks recommended for each frontal part on page 53.
2) For a better performance, use a yellow LED block.





Accessories - Flange Mount

"Front-back" system



Individual Flange¹⁾

Illustrative image	Description	Standard package	Reference	Code
 0.010 kg	Mounting flange with 3 positions for blocks on the frontal part Front-back assembly system	1 piece	AF3F	12670264
		10 pieces	AF3FX10 ²⁾	12918902
 0.015 kg	Mounting flange with 5 positions for blocks on the frontal part Front-back assembly system	1 piece	AF5F	13268324
		5 pieces	AF5FX5 ²⁾	13275324

Single Contact Blocks¹⁾

Illustrative image	Contacts	Diagram	Standard package	Compatible flange	Reference	Code
 0.015 kg	1NO		1 piece	AF3F AF5F	BC10F-CSW	12891184
			10 pieces		BC10F-CSWX10 ²⁾	12174912
	1NC		1 piece		BC01F-CSW	12891186
			10 pieces		BC01F-CSWX10 ²⁾	12174913
	1NOa (early make)		1 piece		BCA10F-CSW	13261897
	1NCr (late break)		1 piece		BCR01F-CSW	13262008

Contact Block to Monitor Emergency-Stop Pushbuttons¹⁾³⁾⁴⁾

Illustrative image	Contacts	Diagram	Standard package	Compatible flange	Reference	Code
 0.015 kg	1NC		1 piece	AF3F	BCM01F-CSW	13262011

Push-On/Push-Off Block¹⁾³⁾

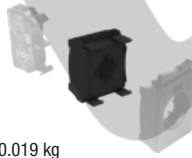
Illustrative image	Description	Standard package	Compatible flange	Reference	Code
 0.019 kg	Mechanical push-on/push-off block for contact blocks mounted on buttons: CSW-BF, CSW-BFI, CSW-BS, CSW-BSI, CSW-BGA, CSW-BC, CSW-BCI Note: use with contact blocks only: - BC01F (1NC) - BCA10F (1NOa - advanced)	1 piece	AF3F	BR-3PF-CSW	13270966

Notes: 1) Not compatible with the PBS control stations. Accessories for base or control stations, see page 40 of this catalog.



























2) Unitary weights.

3) It does not allow front-back assembly.

4) The NO auxiliary contact checks the mechanical assembly.

Accessories - Flange Mount

Illumination Blocks with LEDs¹⁾²⁾

Illustrative image	Voltage codes	Color	Diagram	Standard package	Compatible flange	Reference	Code
 <p>0.016 kg</p>	12 V ac/dc	 Colorless		1 piece	AF3F AF5F	CSW-BIDLF-0E25	12640012
		 Red				CSW-BIDLF-1E25	12640013
		 Green				CSW-BIDLF-2E25	12640014
		 Yellow				CSW-BIDLF-3E25	12640015
		 Blue				CSW-BIDLF-4E25	12640016
	24 V ac/dc	 Colorless				CSW-BIDLF-0E26	12640017
		 Red				CSW-BIDLF-1E26	12640038
		 Green				CSW-BIDLF-2E26	12640039
		 Yellow				CSW-BIDLF-3E26	12640040
		 Blue				CSW-BIDLF-4E26	12640041
	48 V ac/dc	 Colorless				CSW-BIDLF-0E27	12640042
		 Red				CSW-BIDLF-1E27	12640043
		 Green				CSW-BIDLF-2E27	12640044
		 Yellow				CSW-BIDLF-3E27	12640046
		 Blue				CSW-BIDLF-4E27	12640047
	110-130 V ac/dc	 Colorless				CSW-BIDLF-0E10	13899138
		 Red				CSW-BIDLF-1E10	13899139
		 Green				CSW-BIDLF-2E10	13899140
		 Yellow				CSW-BIDLF-3E10	13899141
		 Blue				CSW-BIDLF-4E10	13899142
220-240 V ac	 Colorless	CSW-BIDLF-0D66	12640053				
	 Red	CSW-BIDLF-1D66	12640054				
	 Green	CSW-BIDLF-2D66	12640055				
	 Yellow	CSW-BIDLF-3D66	12640056				
	 Blue	CSW-BIDLF-4D66	12640057				



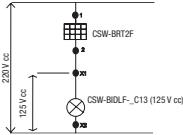
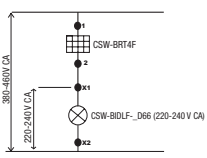

Accessories - Flange Mount

Voltage Reduction Blocks¹⁾³⁾

Illustrative image	Utilization	Input voltage (power supply)	Diagram	Standard package	Compatible flange	Reference	Code
 0.016 kg	Use with the illumination blocks with integrated LED model: CSW-BIDL-F_E10 (110 - 130 V ac / V dc)	220 V ac / V dc		1 piece	AF3F AF5F	CSW-BRT2F	13275624
	Use with the illumination blocks with integrated LED model: CSW-BIDL-F_D66 (220-240 V ac)	380-460 V ac				CSW-BRT4F	13275625

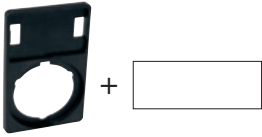
Set of Plate Holder and Plastic Plates¹⁾

Illustrative image	Description	Standard package	Reference	Code
 0.004 kg	Set of plate holder and plastic plate 27 x 18 mm without engraving in black and red for pilot lights, single pushbuttons and selector switches.	5 pieces	APP30 ²⁾	10185880
	Set of plate holder and plastic plate 27 x 18 mm without engraving in black and red for double pushbuttons CSW-BD. Not compatible with CSW2-BD.	5 pieces	APP60 ²⁾	10643837
 0.004 kg	Set of plate holder and plastic plate 27 x 18 mm without engraving, colorless for pilot lights, single pushbuttons and selector switches.	5 pieces	APP30T ²⁾	10185886
	Set of plate holder and plastic plate 27 x 18 mm without engraving, colorless for double pushbuttons CSW-BD. Not compatible with CSW2-BD.	5 pieces	APP60T ²⁾	10583832
 0.004 kg	Plastic plate holder 27 x 18 mm for pilot lights, single pushbuttons and selector switches.	5 pieces	PP30-CSW ²⁾	11427388
	Plastic plate holder 27 x 18 mm for double pushbutton CSW-BD and CSW2-BD/BT.	5 pieces	PP60-CSW ²⁾	11427391

DIN Rail Adapter

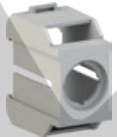
Illustrative image	Description	Standard package	Reference	Code
 0.033 kg	It allows mounting one pushbutton/pilot light/selector switch on 35 mm DIN rail. Note: it does not allow using with the accessories: - Monitored block (BCM01F-CSW). - Mechanical push-on/push-off block (CSW-BRF-3P). - 5-position flange (AF5F).	1 piece	DRCSWA	12846896
	Adapter for 35 mm DIN rail with 10 A socket	1 piece	DRGBW10	15156076
	Adapter for 35 mm DIN rail with 20 A socket		DRGBW20	13033791

Notes: 1) Not compatible with the PBS control stations. Accessories for base or control stations, see page 40 of this catalog.

2) Unitary weights.

3) It allows front-back mounting.

Accessories - Flange Mount

Plate for Emergency-Stop Pushbutton¹⁾

Illustrative image	Description	Standard package	Reference	Code
 0.009 kg	Plate for emergency-stop pushbutton Text: EMERGENCY - STOP	5 pieces	APE ²⁾	10045238
	Plate for emergency-stop pushbutton Text: EMERGENCY - STOP	5 pieces	APE-02 ²⁾	11315980
	Plate for emergency-stop pushbutton Text: EMERGENCY - STOP	5 pieces	APE-03 ²⁾	10077414

Reduction Ring

Illustrative image	Description	Standard package	Reference	Code
 0.030 kg	Reduction ring Ø30 mm to Ø22 mm	1 piece	AR30	10187807

Plastic Shaft

Illustrative image	Description	Standard package	Reference	Code
 0.018 kg	250 mm long plastic shaft	1 piece	SH250	12470467

Silicone Cover³⁾

Illustrative image	Description	Standard package	Reference	Code
 0.010 kg	Additional protection cover for CSW-BD double pushbuttons (IP52) so as to ensure IP66	5 pieces	APBD CSW ²⁾	16374344
	Additional protection cover against solid particles for CSW2-BD double pushbuttons		AP2BD CSW ²⁾	16374471
	Additional protection cover against solid particles for triple CSW2-BT pushbuttons		AP2BT CSW ²⁾	16374472

Notes: 1) Not compatible with the PBS control stations. Accessories for base or control stations, see page 40 of this catalog.

2) Unitary weights.

3) Additional protection cover used in special applications (baking, civil construction, food industry etc.). CSW2-BD double pushbuttons and CSW2-BT triple pushbuttons already have protection rating IP66 without requiring additional covers.



Accessories - Flange Mount

Set of APP30 Plate Holder and Plastic Plate 27x18 mm Already Engraved¹⁾²⁾³⁾

Use with single pushbuttons, pilot lights and selector switches.



+



Standard package
5 pieces

0.015 kg

Single pushbuttons and pilot lights											
Reference	Code	Engraving	Reference	Code	Engraving	Reference	Code	Engraving	Reference	Code	Engraving
APP30-204	11654290	HAND	APP30-208	11654721	RIGHT	APP30-215	11654738	AVANÇO	APP30-229	11654747	SUBIR
APP30-205	11654292	AUTO	APP30-209	11654722	LEFT	APP30-216	11654739	RECUO	APP30-230	11654746	BAJAR
APP30-18 ²⁾	10186656	STOP	APP30-210	11654724	INCH	APP30-125	10212524	LIGA	APP30-231	11654745	ADELANTE
APP30-11	10211995	OPEN	APP30-03 ²⁾	10186652	EMERGENCY STOP	APP30-120	10212519	DESLIGA	APP30-232	11654744	REGRESO
APP30-01	10211988	CLOSE	APP30-05	10186653	JOG	APP30-123	10212522	EM OPERAÇÃO	APP30-233	11654743	PARO
APP30-19	10211999	UP	APP30-06	10211991	JOG FORWARD	APP30-217	11654740	INICIAR	APP30-234	11654742	MARCHA
APP30-02	10211989	DOWN	APP30-07	10211992	JOG REVERSE	APP30-218	11654748	RÁPIDO	APP30-218	11654748	RÁPIDO
APP30-04	10211990	FORWARD	APP30-08	10211993	LOWER	APP30-219	11654751	DEVAGAR	APP30-235	11654741	DESPACIO
APP30-15	10186654	REVERSE	APP30-13	10211997	RAISE	APP30-220	11654755	DIREITA	APP30-236	11654758	DERECHA
APP30-10	10212532	ON	APP30-147	10186991	FAULT	APP30-221	11654757	ESQUERDA	APP30-237	11654760	IZQUIERDA
APP30-132	10212531	OFF	APP30-129	10212528	MANUAL	APP30-222	11654756	PARADA DE EMERGENCIA	APP30-238	11654761	BAJADA
APP30-12	10211996	POWER ON	APP30-52	10652903	AUTOMÁTICO	APP30-223	11654754	ABAIXAR	APP30-239	11654762	SUBIDA
APP30-14	10212533	RESET	APP30-134	10186620	PARADA	APP30-224	11654753	LEVANTAR	APP30-240	11654765	FALLA
APP30-17	10186655	START	APP30-211	11654725	ABRIR	APP30-225	11654752	FALHA	APP30-201	11654226	O
APP30-16	10211998	RUN	APP30-212	11654723	FECHAR	APP30-226	11654750	AUTOMÁTICA	APP30-202	11654227	I
APP30-206	11654293	FAST	APP30-213	11654726	ACIMA	APP30-211	11654725	ABRIR	APP30-203	11654289	II
APP30-207	11654294	SLOW	APP30-214	11654759	ABAIXO	APP30-228	11654749	CERRAR			

2-Position Switch Selectors											
Reference	Code	Engraving	Reference	Code	Engraving	Reference	Code	Engraving	Reference	Code	Engraving
APP30-21	10212001	HAND AUTO	APP30-24	10212004	OFF ON	APP30-28	10212006	UP DOWN	APP30-244	11654909	AVANÇO RECUO
APP30-27	10186658	START STOP	APP30-25	10186657	OPEN CLOSE	APP30-23	10212003	MAN AUTO	APP30-39	10212589	DES LIG
APP30-20	10212000	FOR REV	APP30-26	10212005	RUN JOG	APP30-243	11654908	LIGA DESLIGA	APP30-250	11654914	PARO ARRANQUE
APP30-22	10212002	JOG RUN									







3-Position Switch Selectors											
Reference	Code	Engraving	Reference	Code	Engraving	Reference	Code	Engraving	Reference	Code	Engraving
APP30-30	10186660	FOR OFF REV	APP30-35	10212010	UP OFF DOWN	APP30-257	11654901	ABERTO 0 AUTO	APP30-261	11654903	SUBIR 0 REGRESSO
APP30-32	10212007	MAN OFF AUTO	APP30-149	10647576	AUTO 0 REV	APP30-258	11654902	ABERTO 0 FECHADO	APP30-262	11654917	AUTO 0 REGRESSO
APP30-33	10212008	OPEN OFF AUTO	APP30-255	11654864	AVANÇO 0 RECUO	APP30-190	10289211	SOBE 0 DESCE	APP30-253	11654898	I 0 II
APP30-34	10212009	OPEN OFF CLOSE	APP30-256	11654865	MANUAL 0 AUTO	APP30-260	11654916	AUTO 0 REVERSO			

Double function buttons											
Reference	Code	Engraving	Reference	Code	Engraving	Reference	Code	Engraving	Reference	Code	Engraving
APP30-36	10186554	ON/OFF	APP30-38	10212012	UP/DOWN	APP30-247	11654911	ACIMA/ABAIXO	APP30-251	11654899	ABRIR/CERRAR
APP30-37	10212011	OPEN/CLOSE	APP30-246	11654863	ABRIR/FECHAR	APP30-248	11654912	LIGA/PARO	APP30-252	11654900	SUBIR/BAJAR

Notes: 1) Other engraving and colors on request. Set of APP60 plates also available.
 2) Not compatible with the PBW control stations. Accessories for base or control stations, see page 40 of this catalog.
 3) Unitary weights.

PBW Control Stations - IP66 CE/UL







Empty Control Stations - Hole Ø22 mm¹⁾

Illustrative image	Number of holes	Color		Package	Protection rating	Reference	Code
		Cover	Base				
 0.114 kg	1	Yellow	Gray	1 piece	IP66	PBW-1Y	12204334
 0.114 kg						PBW-1	12204335
 0.152 kg	2					PBW-2	12204336
 0.185 kg	3	Gray				PBW-3	12204337
 0.215 kg	4					PBW-4	12204388
 0.276 kg	6					PBW-6	12204389

Note: 1) It does not allow the mounting of mushroom buttons side by side with other frontal parts; for this assembly do not use the hole next to the mushroom button using the ATR plug accessory. It is not necessary to use the mounting flange for the proper mounting of the frontal parts in the PBW control stations.

PBWL Control Stations - IP66 CE



Empty Control Stations - Hole Ø22 mm¹⁾

Illustrative image	Number of holes	Color		Package	Protection rating	Reference	Code	Weight (kg)
		Cover	Base					
 0.114 kg	1	Yellow	Black	1 piece	IP66	PBWL-1Y-IP66	14485002	0.114
 0.114 kg	1	Gray	Black	1 piece	IP66	PBWL-1-IP66	14484926	0.114
 0.152 kg	2	Gray	Black	1 piece	IP66	PBWL-2-IP66	14484998	0.152
 0.185 kg	3	Gray	Black	1 piece	IP66	PBWL-3-IP66	14484999	0.185
 0.215 kg	4	Gray	Black	1 piece	IP66	PBWL-4-IP66	14485000	0.215
 0.276 kg	6	Gray	Black	1 piece	IP66	PBWL-6-IP66	14485001	0.276

Note: 1) The PBWL-IP66 control stations are compatible with all models of the CEW line of frontal parts but do not guarantee the IP66 protection rating as the CEW line has an IP54 protection rating. For flush pushbuttons (BFM) and double pushbuttons (BDM) using the silicone protection cover (APBF and APBD), the IP66 protection rating can be guaranteed. It does not allow the mounting of mushroom buttons side by side with other frontal parts; for this assembly do not use the hole next to the mushroom button using the ATR plug accessory. It is not necessary to use the mounting flange for the proper mounting of the frontal parts in the PBW control stations.

Accessories - Base/Control Stations Mounting

Contact Blocks²⁾

Illustrative image	Description	Contacts	Diagram	Standard package	Reference	Code
 <p>0.015 kg</p>	Base or DIN rail 35mm mounted single contact blocks	1NC		1 piece	BC01B-CSW	12174857
				10 pieces	BC01B-CSWX10 ³⁾	13163056
		1NO		1 piece	BC10B-CSW	12174856
				10 pieces	BC10B-CSWX10 ³⁾	13163057







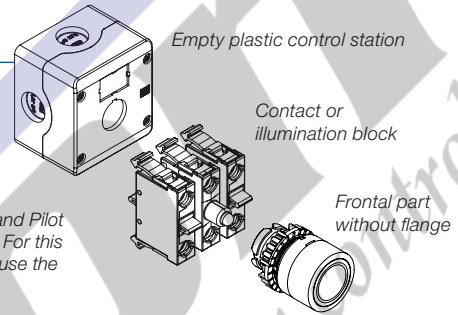



















How to Order

- Frontal Part without flange
- + Contact or illumination blocks
- + Empty plastic control station

Notes: 1) Compatible with all single pushbuttons, knob selector switches and pilot lights of the Pushbuttons and Pilot Lights line. It does not allow mounting mushroom pushbuttons side by side with other frontal parts. For this mounting, close hole next to the mushroom button using the ATR accessory. It is not necessary to use the mounting flange for the proper mounting of the frontal parts in the PBW control stations;
 2) Specific blocks for base mounting or mounting in PBW control stations or 35 mm DIN rail;
 3) Unit weights.







Illumination Blocks with Integrated LED¹⁾

Illustrative image	Voltage codes	Color	Diagram	Standard package	Reference	Code
 <p>0.016 kg</p>	12 V ac/dc			1 piece	CSW-BIDL-0E25	12195732
					CSW-BIDL-1E25	12195737
					CSW-BIDL-2E25	12195839
					CSW-BIDL-3E25	12195840
					CSW-BIDL-4E25	12195842
	24 V ac/dc				CSW-BIDL-0E26	12195847
					CSW-BIDL-1E26	12195918
					CSW-BIDL-2E26	12195919
					CSW-BIDL-3E26	12195920
					CSW-BIDL-4E26	12195921
	48 V ac/dc				CSW-BIDL-0E27	12195922
					CSW-BIDL-1E27	12195923
					CSW-BIDL-2E27	12195924
					CSW-BIDL-3E27	12195926
					CSW-BIDL-4E27	12195948
	110-130 V ac/dc				CSW-BIDL-0E10	13899143
					CSW-BIDL-1E10	13899144
					CSW-BIDL-2E10	13899146
					CSW-BIDL-3E10	13899147
					CSW-BIDL-4E10	13899190
	220-240 V ac				CSW-BIDL-0D66	12196008
					CSW-BIDL-1D66	12196009
					CSW-BIDL-2D66	12196010
					CSW-BIDL-3D66	12196011
		CSW-BIDL-4D66	12196012			

Note: 1) Specific blocks for base mounting or mounting in PBW control stations or 35 mm DIN rail.

Common Accessories (Flange/Base Mounting)

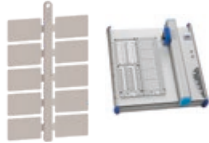





Legend Plates

Illustrative image	Description	Standard package	Reference	Code
 0.006 kg	Black and red legend plates 27x18 mm	5 pieces	AP30 ²⁾	10045237
 0.006 kg	Translucent legend plates 27x18 mm	5 pieces	AP30T ²⁾	10045240
 0.081 kg	White legend plates 27 x 18 mm, mounted on APP30/60 plate holders or on PBW control stations. It allows engraving by means of WEG plotter. Note: Compatible edition software from version: SB-PW_setup5.0.0056_121012.	15 packs with 10 plates	CAP30 ²⁾	12439346
 0.009 kg	Legend plate for emergency-stop pushbutton Text: Portuguese	5 pieces	APEC ²⁾	13050396
	Legend plate for emergency-stop pushbutton Text: English	5 pieces	APEC-02 ²⁾	13050413
	Legend plate for emergency-stop pushbutton Text: Spanish	5 pieces	APEC-03 ²⁾	13050408







Fixing Ring Tool

Illustrative image	Description	Standard package	Reference	Code
 0.017 kg	Fixing ring tool of the fastening ring of the CSW line	1 piece	CAF22	13218642

Lenses for Diffuse Pilot Lights

Illustrative image	Color	Description	Standard package	Reference	Code
 0.004 kg		Lenses to change the color of diffuse pilot lights	5 pieces	ALSD0 ²⁾	10185885
				ALSD1 ²⁾	10185881
				ALSD2 ²⁾	10185882
				ALSD3 ²⁾	10185883
				ALSD4 ²⁾	10185884
				ALSD6 ²⁾	12916460

Engraved Illuminated Pushbutton Caps¹⁾

Illustrative image	Description	Function	Standard package	Reference	Code
 0.006 kg	Engraved internal caps for flush illuminated and extended illuminated pushbutton ¹⁾	 Stop	5 pieces	ALBI30 ²⁾	10211962
		 Start		ALBI31 ²⁾	10211963
		 Linear motion		ALBI32 ²⁾	10211964
		 Clockwise rotation		ALBI33 ²⁾	10211965
		 Counterclockwise rotation		ALBI34 ²⁾	10211966
		 Power supply		ALBI35 ²⁾	10211967

Round Plug

Illustrative image	Description	Standard package	Reference	Code
 0.010 kg	Round plug to close unused Ø22 mm holes	5 pieces	ATR ²⁾	10185878







Notes: 1) Other engraving on request.
2) Unit weights.

Common Accessories (Flange/Base Mounting)









Pushbutton Protection

Illustrative image	Description	Standard package	Reference	Code
 0.010 kg	Additional silicone protection cover for flush pushbuttons (BF) and diffuse pilot lights (SD)	5 pieces	APBF CSW ²⁾	16374343
	Additional silicone protection cover for illuminated flush pushbuttons (BFI), illuminated extended pushbuttons (BSI) and extended pushbuttons (BS)		APBI CSW ²⁾	16374473

Pushbutton Caps

Illustrative image	Description	Color	Standard package	Reference	Code
 0.005 kg	Caps to change the colors of the flush pushbuttons		5 pieces	ACB0 ²⁾	10071881
				ACB1 ²⁾	10045227
				ACB2 ²⁾	10045228
				ACB3 ²⁾	10045229
				ACB4 ²⁾	10045230
				ACB5 ²⁾	10045226
		All the 6 colors	6 pieces	ACB ²⁾	12916461

Engraved Button Caps¹⁾

Illustrative image	Description	Function	Standard package	Reference	Code
 0.005 kg	Engraved caps for flush and guarded pushbuttons ¹⁾		5 pieces	ACB1-30 ²⁾	10045231
				ACB5-31 ²⁾	10045232
				ACB5-32 ²⁾	10045233
				ACB5-33 ²⁾	10045234
				ACB5-34 ²⁾	10045235
				ACB5-35 ²⁾	10045236
				ACB4-37 ²⁾	13526353
				ACB4-47 ²⁾	13526354

Contact Block Tie

Illustrative image	Description	Standard package	Compatible blocks	Reference	Code
 0.002 kg	Contact block tie for monitoring the mechanical assembly together with CSW-BESGM, CSW-BESPM and CSW-BESYM pushbuttons. Maximum number of contact blocks: 3 BC_F/BC_B blocks Note: - It does not allow overlapping the contacts	1 piece	BC10F BC01F BC10B BC01B	CBCSW	13275381

Emergency Pushbutton Protection³⁾

Illustrative image	Description	Standard package	Reference	Code
 0.025 kg	GGuard to avoid inadvertent touch on the emergency-stop pushbutton model CSW-BES4). Mounting in flanges and PBW control stations. WITHOUT engraving	GBES	1	13263711
	Guard to avoid inadvertent touch on the emergency-stop pushbutton model CSW-BES4). Mounting in flanges and PBW control stations. With engraving: EMERGENCY-STOP	GBES-01	1	13888126
	Guard to avoid inadvertent touch on the emergency-stop pushbutton model CSW-BES4). Mounting in flanges and PBW control stations. With engraving: EMERGENCY-STOP	GBES-02	1	13888127
	Guard to avoid inadvertent touch on the emergency-stop pushbutton model CSW-BES4). Mounting in flanges and PBW control stations. With engraving: EMERGENCIA-PARO	GBES-03	1	13888199

Notes: 1) Other engraving on request.

2) Unitary weights.

3) Do not use the emergency pushbutton protection with emergency-stop plates.

4) Compatible with emergency pushbuttons models CSW-BES* only (emergency-stop pushbuttons).

Common Accessories (Flange/Base Mounting)

Plastic Legend Plates 27x18 mm Already Engraved for Use in Empty Control Stations or Plate Holders¹⁾²⁾

START

MANUAL

AUTO

Standard package 5 pieces

0.020 kg

Single pushbuttons and pilot lights											
Reference	Code	Engraving	Reference	Code	Engraving	Reference	Code	Engraving	Reference	Code	Engraving
AP30-204	On request	HAND	AP30-208	On request	RIGHT	AP30-215	On request	AVANÇO	AP30-229	On request	SUBIR
AP30-205	On request	AUTO	AP30-209	On request	LEFT	AP30-216	On request	RECUO	AP30-230	On request	BAJAR
AP30-18 ²⁾	On request	STOP	AP30-210	On request	INCH	AP30-125	12642939	LIGA	AP30-231	On request	ADELANTE
AP30-11	On request	OPEN	AP30-03 ²⁾	On request	EMERGENCY STOP	AP30-120	12642429	DESLIGA	AP30-232	On request	REGRESO
AP30-01	On request	CLOSE	AP30-05	On request	JOG	AP30-123	On request	EM OPERAÇÃO	AP30-233	On request	PARO
AP30-19	On request	UP	AP30-06	On request	JOG FORWARD	AP30-217	On request	INICIAR	AP30-234	On request	MARCHA
AP30-02	On request	DOWN	AP30-07	On request	JOG REVERSE	AP30-218	On request	RÁPIDO	AP30-218	On request	RÁPIDO
AP30-04	On request	FORWARD	AP30-08	On request	LOWER	AP30-219	On request	DEVAGAR	AP30-235	On request	DESPACIO
AP30-15	On request	REVERSE	AP30-13	On request	RAISE	AP30-220	On request	DIREITA	AP30-236	On request	DERECHA
AP30-10	On request	ON	AP30-147	On request	FAULT	AP30-221	On request	ESQUERDA	AP30-237	On request	IZQUIERDA
AP30-132	13724248	OFF	AP30-129	On request	MANUAL	AP30-222	12622820	PARADA DE EMERGENCIA	AP30-238	On request	BAJADA
AP30-12	On request	POWER ON	AP30-52	On request	AUTOMÁTICO	AP30-223	13733881	ABAIXAR	AP30-239	On request	SUBIDA
AP30-14	12642428	RESET	AP30-134	On request	PARADA	AP30-224	13733882	LEVANTAR	AP30-240	On request	FALLA
AP30-17	On request	START	AP30-211	13718112	ABRIR	AP30-225	On request	FALHA	AP30-201	On request	0
AP30-16	On request	RUN	AP30-212	On request	FECHAR	AP30-226	On request	AUTOMÁTICA	AP30-202	On request	I
AP30-206	On request	FAST	AP30-213	On request	ACIMA	AP30-211	On request	ABRIR	AP30-203	On request	II
AP30-207	On request	SLOW	AP30-214	On request	ABAIXO	AP30-228	On request	CERRAR			

2-Position Selector Switches											
Reference	Code	Engraving	Reference	Code	Engraving	Reference	Code	Engraving	Reference	Code	Engraving
AP30-21	13724250	HAND AUTO	AP30-24	On request	OFF ON	AP30-28	On request	UP DOWN	AP30-244	On request	AVANÇO RECUO
AP30-27	On request	START STOP	AP30-25	On request	OPEN CLOSE	AP30-23	On request	MAN AUTO	AP30-39	On request	DES LIG
AP30-20	On request	FOR REV	AP30-26	On request	RUN JOG	AP30-243	12720641	LIGA DESLIGA	AP30-250	On request	PARO ARRANQUE
AP30-22	On request	JOG RUN									

3-Position Selector Switches											
Reference	Code	Engraving	Reference	Code	Engraving	Reference	Code	Engraving	Reference	Code	Engraving
AP30-30	On request	FOR OFF REV	AP30-35	On request	UP OFF DOWN	AP30-257	On request	ABERTO 0 AUTO	AP30-261	On request	SUBIR 0 REGRESSO
AP30-32	On request	MAN OFF AUTO	AP30-149	On request	AUTO 0 REV	AP30-258	On request	ABERTO 0 FECHADO	AP30-262	On request	AUTO 0 REGRESSO
AP30-33	On request	OPEN OFF AUTO	AP30-255	On request	AVANÇO 0 RECUO	AP30-190	13855859	SOBE 0 DESCE	AP30-253	On request	I 0 II
AP30-34	On request	OPEN OFF CLOSE	AP30-256	On request	MANUAL 0 AUTO	AP30-260	On request	AUTO 0 REVERSO			

Notes: 1) Other engraving and colors on request.
2) All weights above are unitary.

Assembled Units - Ø22 mm - IP66

Button with Shaft

Illustrative image	Description	Reference	Code	Weight (kg)
	Flush pushbutton - Blue - "RESET" Engraved - With 22.5 mm to 250 mm long shaft	CSW-BHF437	12471376	0.045

Non-Illuminated Pushbuttons

Illustrative image	Description	Reference	Code	Weight (kg)
	Flush pushbutton - Black - 1 NO	CSW-BF5-10000000-3VF	12923176	0.041
	Flush pushbutton - Blue - Engraving: "RESET" - 1 NO	CSW-BF437-10000000-3VF	12922280	
	Flush pushbutton - Blue - 1 NO	CSW-BF4-10000000-3VF	12923199	
	Flush pushbutton - Yellow - 1 NO	CSW-BF3-10000000-3VF	12930986	
	Flush pushbutton - Green - 1 NO	CSW-BF2-10000000-3VF	12923177	
	Flush pushbutton - Red - 1 NC	CSW-BF1-01000000-3VF	12922955	
	Mushroom pushbutton - Green - 1 NO	CSW-BC2-10000000-3VF	12930987	0.044
	Mushroom pushbutton - Red - 1 NO	CSW-BC1-01000000-3VF	12931019	0.277
	Emergency-stop pushbutton - Twist-to-Release - 3 NC monitored	CSW-BESG-00000003-3VF	13312574	
	Emergency-stop pushbutton - Twist-to-Release - 2 NC monitored	CSW-BESG-00000002-3VF	13312575	
	Emergency-stop pushbutton - Twist-to-Release - 1 NC monitored	CSW-BESG-00000001-3VF	13278311	
	Emergency-stop pushbutton - Pull-to-Release - 3 NC monitored	CSW-BESP-00000001-3VF	13278309	
	Emergency-stop pushbutton - Pull-to-release - 2 NC monitored	CSW-BESP-02000000-3VF	12922949	
	Emergency-stop pushbutton - Twist-to-release - 1 NC (BC01F)	CSW-BESG-01000000-3VF	12922954	
	Emergency-stop pushbutton - Pull-to-release - 1 NC (BC01F)	CSW-BESP-01000000-3VF	12931118	
	Emergency-stop pushbutton - Twist-to-release with side signaling - 1 NC monitored	CSW-BESGS-00000001-3VF	13278312	
	Emergency-stop pushbutton - Pull-to-release - Allows monitoring of mounting in PBW control stations or AF3F flange - 1NC (BC01F) and 1NO (BC10F)	CSW-BESPM-11000000-3VF	13307985	
	Emergency pushbutton with lock (key unlocked) - 1 NC monitored	CSW-BESY-01000000-3VF	13770800	
Flush Double pushbutton IP52 - Green (Engraved: "I") and Red (Engraved: "O") - 1 NO + 1 NC	CSW-BD-11000000-3VF	12923175	0.055	
Flush Double pushbutton IP66 - Green (Engraved: "I") and Red (Engraved: "O") - 1 NO + 1 NC	CSW2-BDF2110-11000000-3VF	12756198		

Illuminated Pushbuttons

Illustrative image	Description	Reference	Code	Weight (kg)
	Illuminated flush double pushbutton IP52 - Green (Engraved: "I") and Red (Engraved: "O") - 220-240 V ac - 1 NO + 1 NC	CSW-BD-11000000-FD661-3VF	12923174	0.055
	Illuminated flush double pushbutton IP52 - Green (Engraved: "I") and Red (Engraved: "O") - 110-130 V ac/dc - 1 NO + 1 NC	CSW-BD-11000000-FE101-3VF	12931024	
	Illuminated flush double pushbutton IP52 - Green (Engraved: "I") and Red (Engraved: "O") - 24 V ac/dc - 1 NO + 1 NC	CSW-BD-11000000-FE261-3VF	12931058	
	Illuminated flush double pushbutton IP66 - Green (Engraved: "I") and Red (Engraved: "O") - 220-240 V ac - 1 NO + 1 NC	CSW2-BDF2110-11000000-FD661-3VF	12931201	
	Illuminated flush pushbutton - Red - 220-240 V ac - 1 NC	CSW-BF1-01000000-FD66-3VF	12931064	0.054
	Illuminated flush pushbutton - Red - 24 V ac/dc - 1 NC	CSW-BF1-01000000-FE26-3VF	12931066	
	Illuminated flush pushbutton - Green - 220-240 V ac - 1 NO	CSW-BF12-10000000-FD66-3VF	12931067	
	Illuminated flush pushbutton - Green - 24 V ac/dc - 1 NO	CSW-BF12-10000000-FE26-3VF	12931090	
	Illuminated flush pushbutton - Yellow - 24 V ac/dc - 1 NO	CSW-BF13-10000000-FE26-3VF	12931092	
	Illuminated flush pushbutton - Blue - 24 V ac/dc - 1 NO	CSW-BF14-10000000-FE26-3VF	12931093	
	Extended pushbutton - Green - 220-240 V ac - 1 NO	CSW-BSI2-10000000-FD66-3VF	12931094	

Non-Illuminated Selector Switches

Illustrative image	Description	Reference	Code	Weight (kg)
	Selector switch knob - Black - 2 positions maintained - 45° - 1 NO	CSW-CK2F45-10000000-3VF	12923170	0.046
	Selector switch knob - Black - 2 positions maintained - 90° - 1 NO + 1 NC	CSW-CK2F90-11000000-3VF	12923198	0.57
	Selector switch knob - Black - 2 positions maintained - 90° - 1 NO	CSW-CK2F90-10000000-3VF	12923253	0.046
	Selector switch knob - Black - 2 positions maintained - 90° - 2 NO	CSW-CK2F90-20000000-3VF	12931095	0.057
	Selector switch knob - Black - 2 positions maintained - 45° - 1 NO + 1 NC	CSW-CK2F45-11000000-3VF	12931096	
	Selector switch knob - Black - 3 positions momentary - 45° - 2 NO	CSW-CK3R45-20000000-3VF	12923020	
	Selector switch knob - Black - 3 positions maintained - 45° - 2 NO	CSW-CK3F45-20000000-3VF	12923168	

Assembled Units - Ø22 mm - IP66

Illuminated Selector Switches

Illustrative image	Description	Reference	Code	Weight (kg)
	Illuminated selector switch - Red - 2 positions maintained - 90° - 1 NO - 220-240 V ac	CSW-CKI2F901-10000000-FD66-3VF	12930906	0.053
	Illuminated selector switch - Green - 2 positions maintained - 90° - 1 NO - 220-240 V ac	CSW-CKI2F902-10000000-FD66-3VF	12930907	
	Illuminated selector switch - Green - 2 positions maintained - 90° - 1 NO - 110-130 V ac/dc	CSW-CKI2F902-10000000-FDE10-3VF	12930958	
	Illuminated selector switch - Red - 2 positions maintained - 90° - 1 NO - 110-130 V ac/dc	CSW-CKI2F901-10000000-FE10-3VF	12930960	
	Illuminated selector switch - Red - 2 positions maintained - 90° - 2 NO - 220-240 V ac	CSW-CKI2F901-20000000-FD66-3VF	12930961	0.063
	Illuminated selector switch - Red - 2 positions maintained - 90° - 1 NO - 24 V ac/dc	CSW-CKI2F901-10000000-FE26-3VF	12930962	
	Illuminated selector switch - Red - 2 positions maintained - 90° - 1 NC - 220-240 V ac	CSW-CKI2F901-10000000-FD66-3VF	12930966	0.053
	Illuminated selector switch - Green - 2 positions maintained - 90° - 2 NO - 24 V ac/dc	CSW-CKI2F902-10000000-FE26-3VF	12930965	
	Illuminated selector switch - Red - 3 positions maintained - 45° - 2 NO - 110-130 V ac/dc	CSW-CKI3F451-20000000-FE10-3VF	12930980	0.063
	Illuminated selector switch - Green - 3 positions maintained - 45° - 2 NO - 110-130 V ac/dc	CSW-CKI3F452-20000000-FE10-3VF	12930981	
	Illuminated selector switch - Green - 3 positions maintained - 45° - 2 NO - 24 V ac/dc	CSW-CKI3F452-20000000-FE26-3VF	12930982	
	Illuminated selector switch - Red - 3 positions maintained - 45° - 1 NO + 1 NC - 220-240 V ac	CSW-CKI3F451-11000000-FD66-3VF	12930983	
	Illuminated selector switch - Red - 3 positions maintained - 45° - 2 NO - 220-240 V ac	CSW-CKI3F451-20000000-FD66-3VF	12930984	
	Illuminated selector switch - Green - 3 positions maintained - 45° - 2 NO - 220-240 V ac	CSW-CKI3F452-20000000-FD66-3VF	12930985	

Modular Pilot Lights with LED Blocks

Illustrative image	Description	Reference	Code	Weight (kg)
	White diffuse pilot light - LED Block 24 V ac/dc - White	CSW-SD0-FE26-3VF	12930828	0.039
	Red diffuse pilot light - LED Block 24 V ac/dc - Red	CSW-SD1-FE26-3VF	12930829	
	Green diffuse pilot light - LED Block 24 V ac/dc - Green	CSW-SD2-FE26-3VF	12930830	
	Yellow diffuse pilot light - LED Block 24 V ac/dc - Yellow	CSW-SD3-FE26-3VF	12930831	
	Blue diffuse pilot light - LED Block 24 V ac/dc - Blue	CSW-SD4-FE26-3VF	12930832	
	Orange diffuse pilot light - LED Block 24 V ac/dc - Orange	CSW-SD6-FE26-3VF	12930833	
	White diffuse pilot light - LED Block 48 V ac/dc - White	CSW-SD0-FE27-3VF	12930834	
	Red diffuse pilot light - LED Block 48 V ac/dc - Red	CSW-SD1-FE27-3VF	12930835	
	Green diffuse pilot light - LED Block 48 V ac/dc - Green	CSW-SD2-FE27-3VF	12930836	
	Yellow diffuse pilot light - LED Block 48 V ac/dc - Yellow	CSW-SD3-FE27-3VF	12930837	
	Blue diffuse pilot light - LED Block 48 V ac/dc - Blue	CSW-SD4-FE27-3VF	12930878	
	Orange diffuse pilot light - LED Block 48 V ac/dc - Orange	CSW-SD6-FE27-3VF	12930879	
	White diffuse pilot light - LED Block 110-130 V ac/dc - White	CSW-SD0-FED10-3VF	12930880	
	Red diffuse pilot light - LED Block 110-130 V ac/dc - Red	CSW-SD1-FED10-3VF	12930881	
	Green diffuse pilot light - LED Block 110-130 V ac/dc - Green	CSW-SD2-FE10-3VF	12930882	
	Yellow diffuse pilot light - LED Block 110-130 V ac/dc - Yellow	CSW-SD3-FE10-3VF	12930883	
	Blue diffuse pilot light - LED Block 110-130 V ac/dc - Blue	CSW-SD4-FE10-3VF	12930884	
	Orange diffuse pilot light - LED Block 110-130 V ac/dc - Orange	CSW-SD6-FE10-3VF	12930885	
	White diffuse pilot light - LED Block 220-240 V ac - White	CSW-SD0-FD66-3VF	12930902	
	Red diffuse pilot light - LED Block 220-240 V ac - Red	CSW-SD1-FD66-3VF	12923060	
	Green diffuse pilot light - LED Block 220-240 V ac - Green	CSW-SD2-FD66-3VF	12923059	
	Yellow diffuse pilot light - LED Block 220-240 V ac - Yellow	CSW-SD3-FD66-3VF	12930903	
	Blue diffuse pilot light - LED Block 220-240 V ac - Blue	CSW-SD4-FD66-3VF	12930904	
	Orange diffuse pilot light - LED Block 220-240 V ac - Orange	CSW-SD6-FD66-3VF	12930905	

Emergency-Stop Pushbuttons on Decentralized Control Station¹⁾

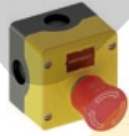
Illustrative image	Control Station	Emergency-stop pushbutton	Contact blocks	Engraved plate	Plate color	Reference	Code	Weight
	PBW-1Y	CSW-BESGM	1NO + 1NC	"EMERGENCY STOP"	Red	PBW1Y-GM11V03	13232101	0.212
	PBW-1Y	CSW-BESGM	1NO + 2NC	"EMERGENCY STOP"	Red	PBW1Y-GM12V03	13232498	0.212
	PBW-1Y	CSW-BESPM	1NO + 1NC	"EMERGENCY STOP"	Red	PBW1Y-PM11V03	13232102	0.212
	PBW-1Y	CSW-BESPM	1NO + 2NC	"EMERGENCY STOP"	Red	PBW1Y-PM12V03	13232499	0.212

Note: 1) Other configurations on request.

Coding

Set with Button or Pilot Light Frontal Part

Short description example: CSW-SD1-00000000E10-3VF

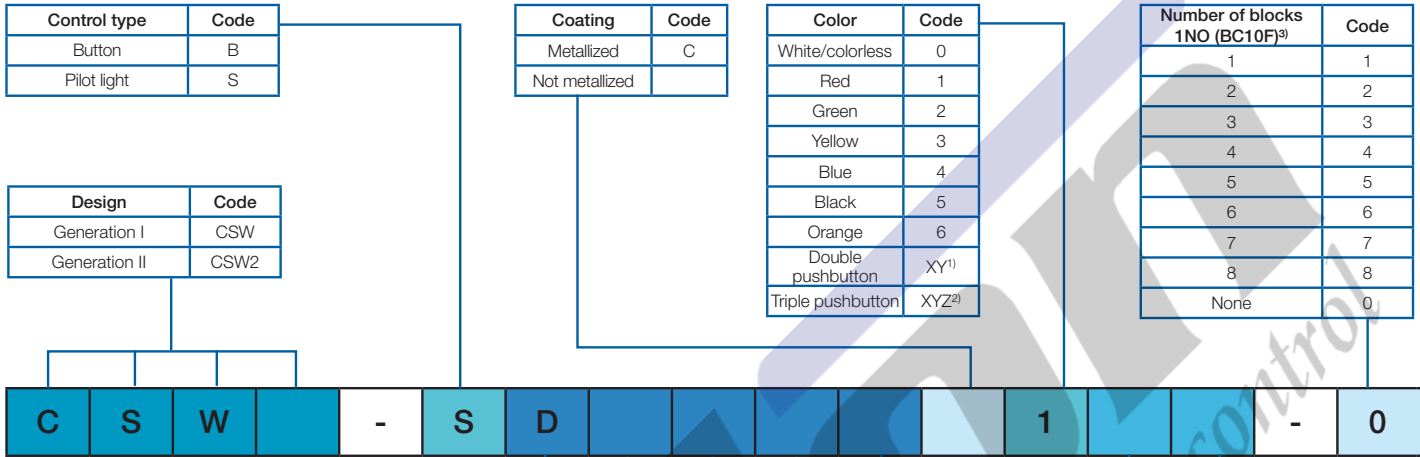

Control type	Type of frontal part	Code
B	Flush	F
	Illuminated flush	FI
	Extended	S
	Illuminated Extended	SI
	Guarded	GA
	Mushroom	C
	Illuminated Mushroom	CI
	Mushroom with key	CY
	Mushroom with 455 key	CW
	Mushroom with latch	CT
	Heavy duty mushroom	CHD
	Pull-to-release emergency-stop (EN 418)	ESP
	Twist-to-release emergency-stop (EN 418)	ESG
	Monitored pull-to-release emergency-stop (EN 418)	ESPM
	Monitored twist-to-release emergency-stop (EN 418)	ESGM
	Emergency-stop pull-to-release side signaling (EN 418)	ESPS
	Emergency-stop twist-to-release side signaling (EN 418)	ESGS
	Emergency-stop pull-to-release side signaling (EN 418)	ESPSM
	Emergency-stop twist-to-release monitored and side signaling (EN 418)	ESGSM
	Emergency-stop with key (EN 418)	ESY
	Emergency-stop with 455 key (EN 418)	ESW
	Pull-to-release emergency-stop with front mechanical signaling (EN 418)	ESPF
	Twist-to-release emergency-stop with front mechanical signaling (EN 418)	ESGF
	Monitored pull-to-release emergency-stop with front mechanical signaling (EN 418)	ESPFM
	Monitored twist-to-release emergency-stop with front mechanical signaling (EN 418)	ESGFM
	Pull-to-release emergency-stop with front mechanical signaling + side signaling (EN 418)	ESPSF
	Twist-to-release emergency-stop with front mechanical signaling + side signaling (EN 418)	ESGSF
	Monitored pull-to-release emergency-stop with front mechanical signaling + side signaling (EN 418)	ESPSFM
	Monitored twist-to-release emergency-stop with front mechanical signaling + side signaling (EN 418)	ESGSFM
	Pull-to-release emergency-stop with front lighting signaling (EN 418)	ESPL
	Twist-to-release emergency-stop with front lighting signaling (EN 418)	ESGL
	Monitored pull-to-release emergency-stop with front lighting signaling (EN 418)	ESPLM
	Monitored twist-to-release emergency-stop with front lighting signaling (EN 418)	ESGLM
	Pull-to-release emergency-stop with front lighting signaling + side signaling (EN 418)	ESPLS
	Twist-to-release emergency-stop with front lighting signaling + side signaling (EN 418)	ESGLS
	Monitored pull-to-release emergency-stop with front lighting signaling + side signaling (EN 418)	ESPLSM
	Monitored twist-to-release emergency-stop with front lighting signaling + side signaling (EN 418)	ESGLSM
	Double flush IP52	D
	Double flush IP66 (CSW2)	DF
	Double flush illuminated IP66 (CSW2)	DFI
	Double extended IP66 (CSW2)	DS
	Double extended illuminated IP66 (CSW2)	DSI
Triple flush IP66 (CSW2)	TF	
Triple extended IP66 (CSW2)	TS	
Flush with shaft	HF	
Extended with shaft	HS	
S	Diffuse	D

Frontal part engraving
According to the table on page 50 of the catalog

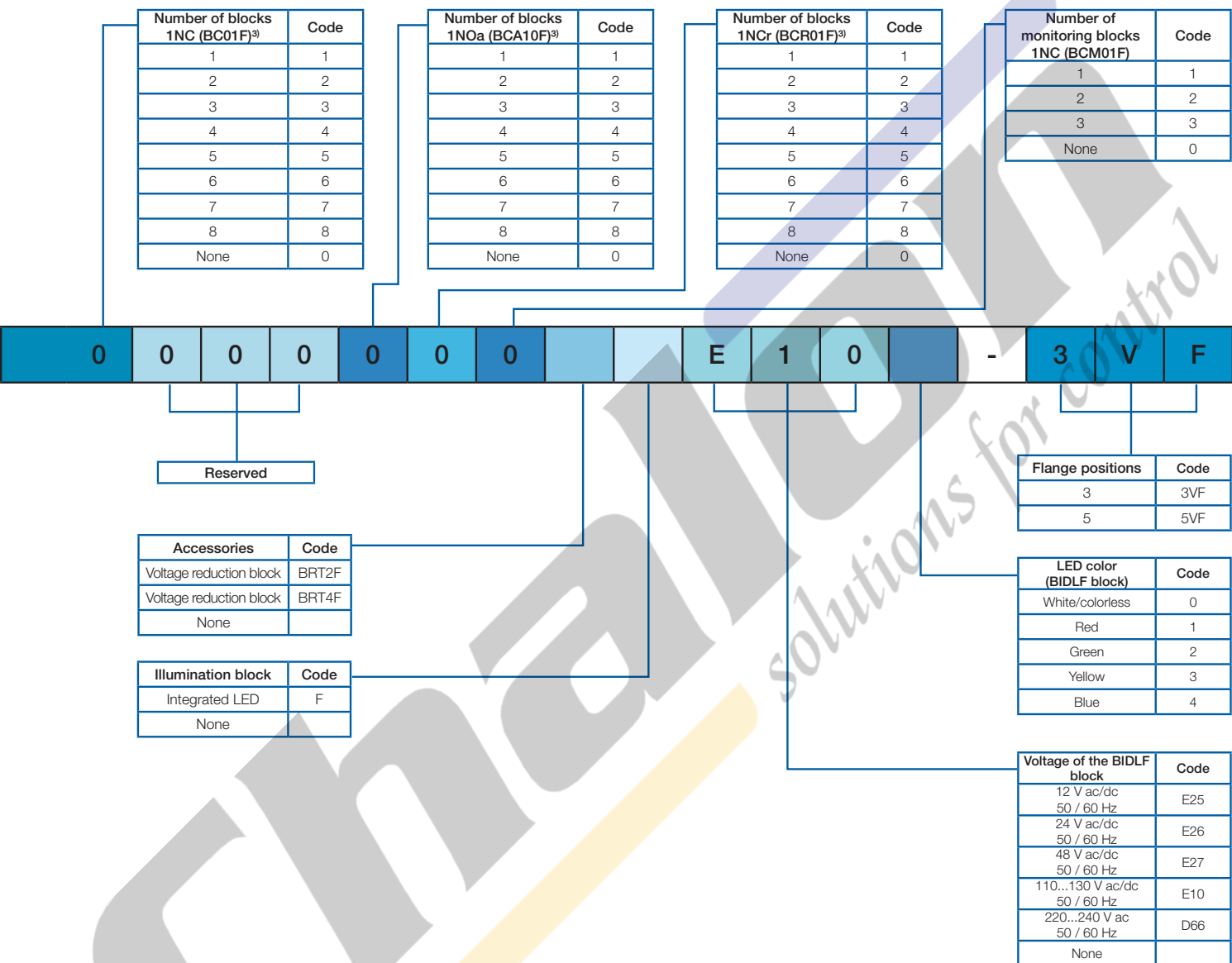

Notes: 1) For double pushbutton, use the code with 2 numbers:



2) For triple pushbutton, use the code with 3 numbers:

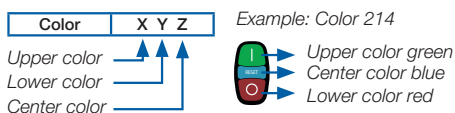

Available center colors: Red (1) or Blue (4).

3) Check the maximum number of blocks recommended in the table "Maximum Contact Configurations" on page 53.

This coding is not valid for using the selector switch frontal part type.

Coding

Set Assembled with Selector Switch Frontal Part Type

Short description example: CSW-CKI3RE453-1000000FD66-3VF

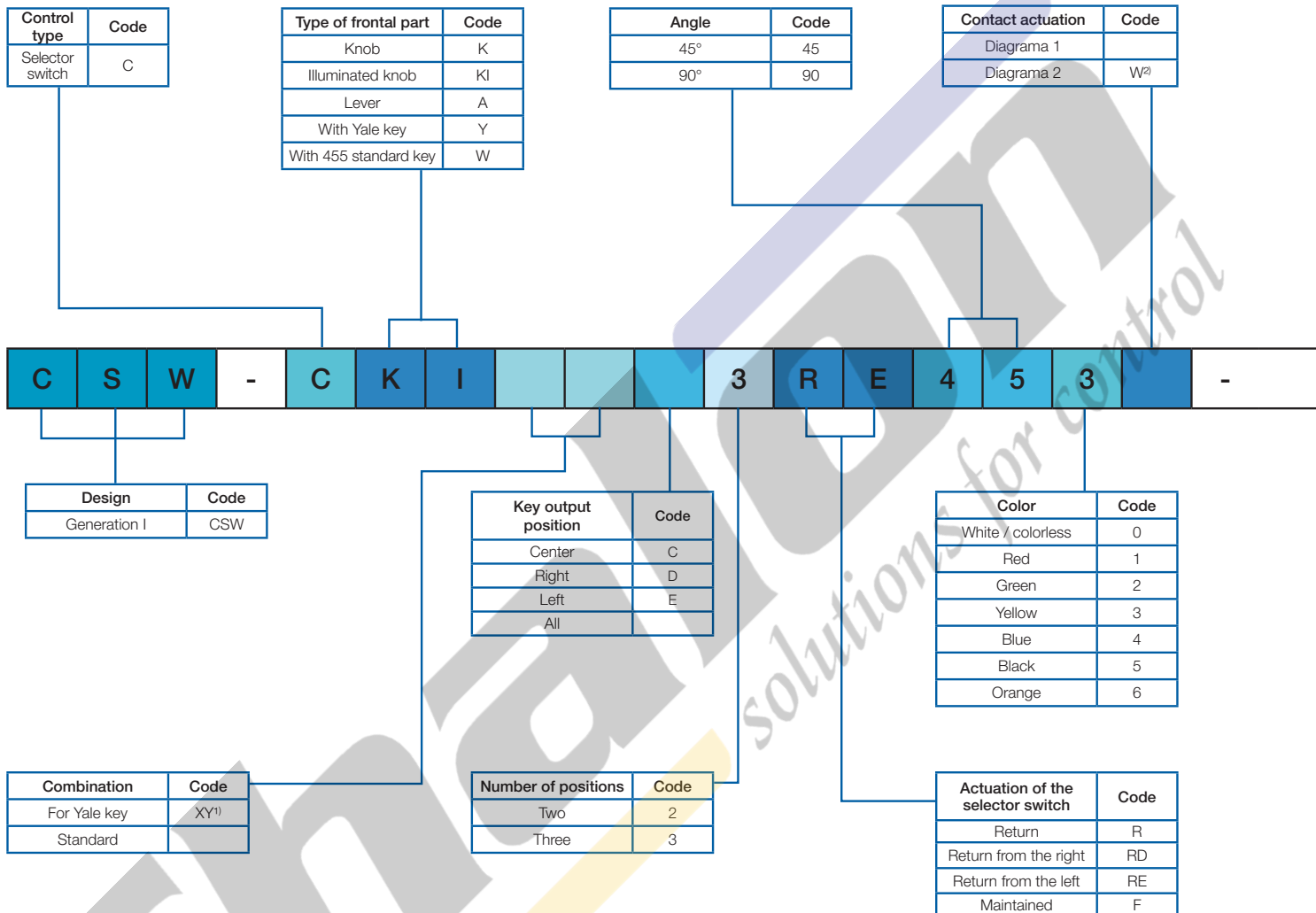



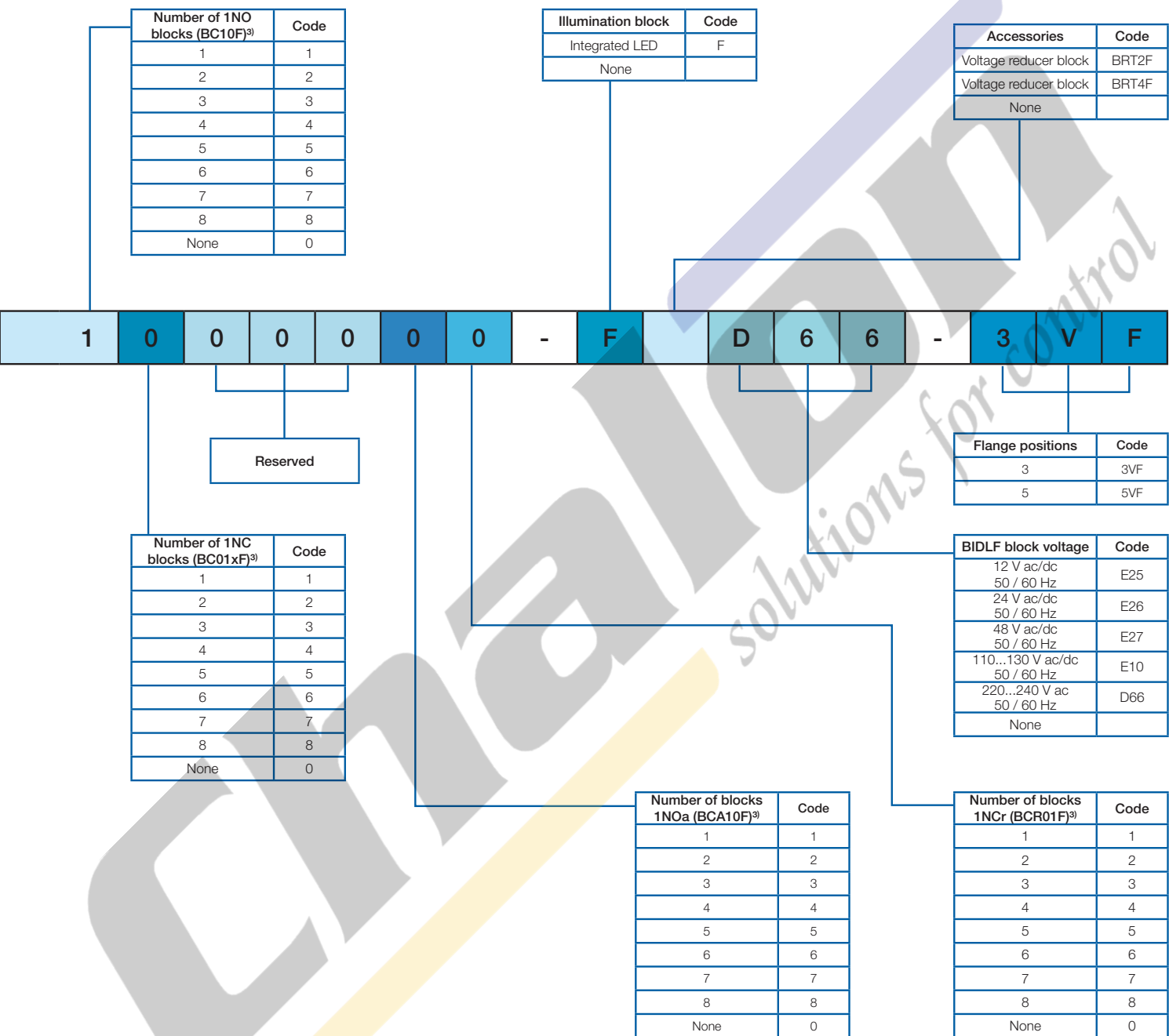











































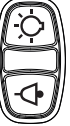



Notes: 1) Available combinations: 01, 10, 11, 12, 13, 14, 15, 16, 17, 18, 19, 20, 21, 22, 23, 24, 25, 26, 27, 28, 29. More combinations on request.
 2) Valid for non-illuminated 2-position selector switches. See diagram 2 of the table "Contact Actuation Type" on page 29.
 3) Check the maximum number of blocks recommended in the table "Maximum Contact Configurations" on page 53. This coding is not valid for the use of the push-button/signal type frontal part.



Coding

Table of Codes and Drawings for Engraving on the Front Part of the Buttons

Gravação						
						
30	31	32	33	34	35	36
						
37	38	39	40	41	42	43
						
44	45	47	50	54	55	59
						
46	48	49	51	52	53	56
						
57	58	10	10-H	SS	LD	III
						
FR	PN	RL	MP	LA	LH	C1C2
						
00	PS	R	D	M	PO	RM
						
S	P	PE				

Technical Data

Pushbuttons, Selector Switches and Pilot Lights

Applicable standards	IEC 60947-5-1, VDE 0660, UL 508, CENELEC EN 50007, ISO 13850 (EN 418), IEC 60947-5-5
Certifications	CE, cULus, BV, IRAM, PCT, RCC, ICONTEC
Protection rating	IP66 and IP52 (CSW-BD) according to IEC 60529 NEMA1, 2, 3, 3R, 3S, 4, 4X, 5, 12, 12K and 13 according to UL 508
Materials of the frontal parts	Polyamide (PA66) or Polycarbonate (PC)
Mechanical life	
Buttons	3 x 10 ⁶ operations
CSW2-BD and CSW2-BT pushbuttons	2 x 10 ⁶ operations
CSW-BEG/EY/CT/CY/CW pushbuttons	3 x 10 ⁵ operations
Selector switches	1 x 10 ⁶ operations
CSW-BESG/P/Y/W emergency-stop pushbuttons	1 x 10 ⁵ operations
CSW-BESG_I (lighting emergency-stop pushbuttons)	5 x 10 ⁴ operations
Use in environments	Outdoors (UV rays) or indoors
Working temperature range	-25 °C ... 70 °C

Contact Blocks

Applicable standards	IEC 60947-5-1, VDE 0660, UL 508, CENELEC EN 50007, ISO 13850 (EN 418), IEC 60947-5-5			
Certifications	CE, cULus, BV, IRAM, PCT, RCC, ICONTEC			
Rated insulation voltage U _i	690 V			
Rated impulse-withstand voltage U _{imp}	4 kV			
Protection rating (IEC 60529)	IP20			
Conventional thermal current I _{th}	10 A			
Electrical performance according to IEC 60947-5-1				
Utilization category AC-15	BC...-CSW		BCM01-CSW	
	U _e (V ac)	I _e (A)	U _e (V ac)	I _e (A)
	24	10	24	6
	48	10	48	6
	60	10	60	6
	110	6	110	6
	220	3	220	3
Utilization category DC-13	BC...-CSW		BCM01-CSW	
	U _e (V dc)	I _e (A)	U _e (V dc)	I _e (A)
	24	2.5	24	2.5
	48	1.4	48	1.4
	60	1	60	1
	110	0.55	110	0.55
	220	0.27	220	0.27
Performance according to UL and CSA	AC / Heavy Duty (A600) and DC / Standard Duty (Q600)		-	
	Resistance of the contacts (IEC 60255) ≤ 25m Ω			
Protection against short circuit (IEC 60269-1 / IEC 60269-3)	BC...-CSW: Fuse of 16 A / 690 V gL/gG (1 kA) Mini-circuit breaker of 16 A (MDW-B16)		Fuse of 6 A / 500 V gL/gG (0.5 kA) Mini-circuit breaker of 6 A (MDW-B6)	
	BC...F-CSW (Front-back) and BC...B-CSW (Control Stations): Fuse of 10 A / 690 V gL/gG (1 kA) Mini-circuit breaker of 10 A (MDW-B10)			
Protection against electric shock (IEC 61140)	Class II			
Section of the conductors (wire/cable with or without terminal)	Minimum (1 x 0.5 mm ²) and maximum (2 x 2.5 mm ²)			
Tightening torque	0.8 N.m			
Working temperature range	-25 °C...+70 °C			
Resistance to mechanical shock	Without damages or disassembly 100 g (1/2 sinusoidal 11ms, according to MIL 202 B method 202 A)			
Resistance to vibration (IEC 60068-2-6)	16 g for a frequency range from 40 to 500 Hz. Maximum displacement 0.75 mm (peak to peak)			
Mechanical life of the BC10F / BC01F / BCA10F / BCR01F contact blocks	1 x 10 ⁶ operations			

Technical Data

Illumination Blocks with Integrated LED BIDL

Applicable standards	IEC 60947-5-1, UL 508
Voltage range for operation	0.85...1.10 x Ue
Protection rating (IEC 60529)	IP20
Consumption (V ac/ V dc)	10 mA
Rated impulse-withstand voltage Ui (IEC 60947-1)	2.5 kV
Operating temperature range	- 25 °C...+70 °C
Average useful life	100,000 hours
Brightness	Red 70 mcd
	Yellow 115 mcd
	White 275 mcd
	Blue 64 mcd
	Green 150 mcd
Section of the conductors (wire/cable with or without terminal)	Minimum (1 x 0.5 mm ²) and maximum (2 x 2.5 mm ²)
Tightening torque	0.8 N.m

Empty Plastic Boxes - PBW / PBWL





Applicable standards	IEC 60947-5-1, IEC 50102, IEC 60529, UL 508, UL 50
Certifications	UL / CE
Protection rating (IEC 60529)	IP66 (NEMA 4X)
Working temperature range	-25 °C...+70 °C
Material	ABS and Polycarbonate (cover and base)
Color of the cover	Grey (RAL 7035) or yellow (RAL 1003)
Color of the base	Black (RAL 9005)
Cable gland entries	ØM20 / PG13.5 / 1/2" and ØM16 / 3/8"
Use in environments	Outdoors (UV rays) or indoors







Note: PBWL control stations are CE certified only.

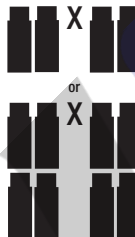
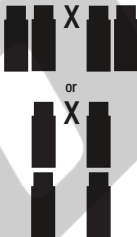
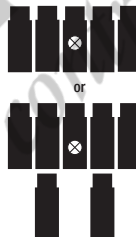

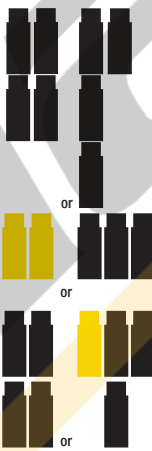

Assembly Configurations

Maximum Recommended Configurations of Blocks for Each Frontal Part and Flange

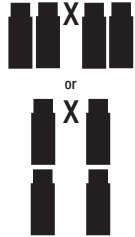
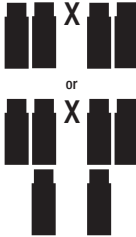
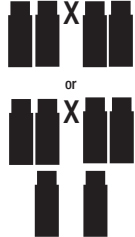
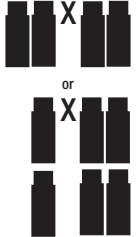
Type of frontal part	Illuminated selector switch	Non-illuminated selector switch	Illuminated pushbuttons			
Basic reference	CSW-CKI	CSW-CK, CSW-CA, CSW-CY	CSW2-BDFI, CSW2-BDSI	CSW-BCI, CSW-BD, CSW-BFI, CSW-BSI		
Maximum number of contacts	Max 4	Max 6	Max 4	Max 6		
AF3F flange (3 positions)						
Maximum number of contacts	Max 4	Max 8	Max 4	Max 6		
AF5F flange (5 positions) ¹⁾						

Type of frontal part	Non-illuminated pushbuttons						
Basic reference	CSW-BESGM, CSW-BESPM, CSW-BESYM	CSW-BESG, CSW-BESP, CSW-BESY	CSW2-BDF, CSW2-BDS	CSW-BF, CSW-BGA	CSW-BC, CSW-BS	CSW-BEG, CSW-BCT, CSW-BCY	CSW2-BT
Maximum number of contacts	Max 3	Max 4	Max 4	Max 6	Max 6	Max 6	Max 7
AF3F flange (3 positions)							
Maximum number of contacts	-	Max 4	Max 4	Max 4	Max 4	Max 4	-
AF5F flange (5 positions) ²⁾	-	-					-

 BC10F-CSW contact blocks
 BC01F-CSW contact blocks

 BCM01-CSW monitoring contact blocks

 BIDLf illumination blocks

 CBCSW contact block tie

 Location not permitted

Notes: 1) In the central position of the AF5F flange, use illumination blocks only.
 2) Do not use monitoring blocks with the AF5F flange. Do not use emergency-stop pushbuttons with the AF5F flange.

Installation and Mounting

Installation on Flange

Installation on Flange Fitting and Positioning

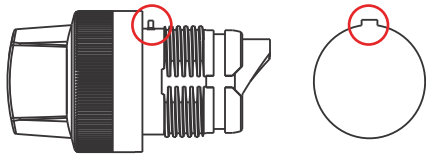

Latch on the body of the frontal part and holes with slot will prevent the rotation of the frontal part during its mounting or operation.

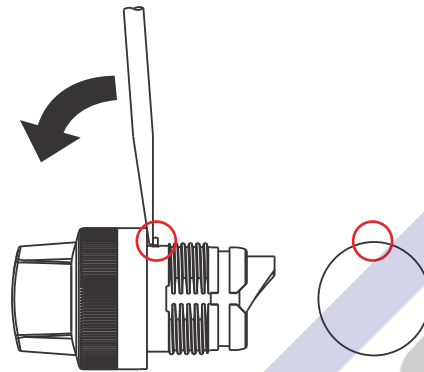

Latch on the body of the frontal part can be removed for installation in round hole, but it may rotate.

Mounting

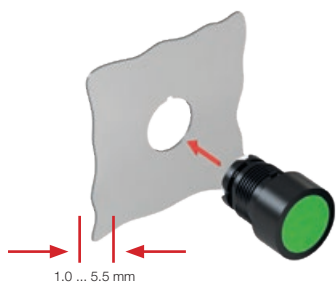

Install the frontal part without fastening nut.



Screw the fastening nut.



Tighten with the fastening wrench.

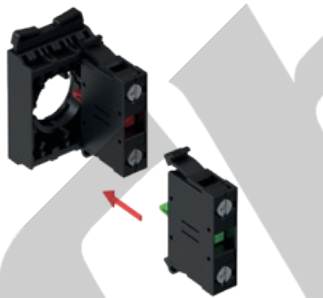

Fit the blocks onto the flange.

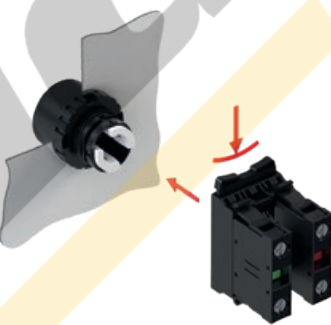

Press the snap fit to connect the flange to the frontal part.

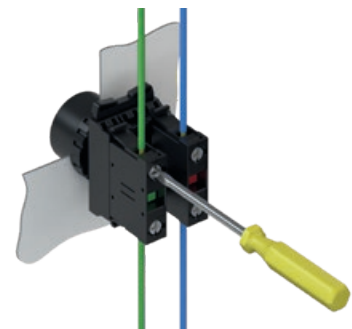

Make electric wiring.

Disassembly

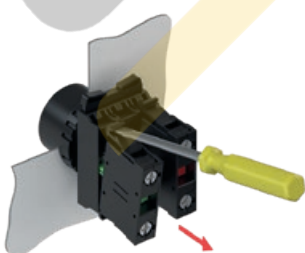

Place the screwdriver at the ends of the block so as to disconnect it from the flange.



Press the snap fit to remove the flange from the frontal part.

Installation and Mounting

Installation in PBW Control Stations

Fitting and Positioning

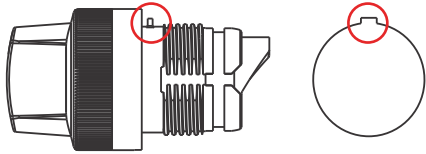

Latch on the body of the frontal part and slot on the holes of the PBW control stations will prevent the rotation of the frontal part during its mounting or operation.

Mounting



Install the frontal part without fastening nut.

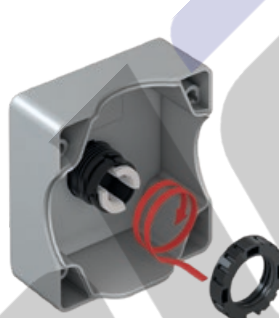

Screw the fastening nut.

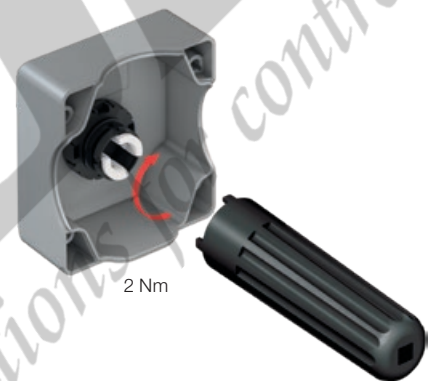

Tighten with the fastening wrench.

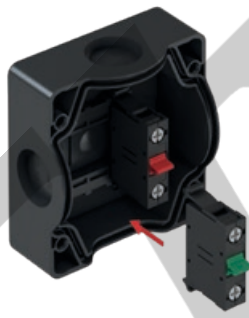

Fit the blocks on the control station base.

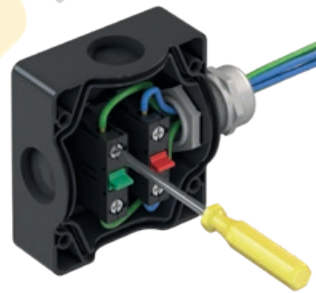

Make electric wiring.

Disassembly

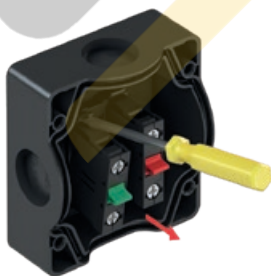

Place the screwdriver at the ends of the block so as to disconnect it from the flange.

Dimensions (mm)

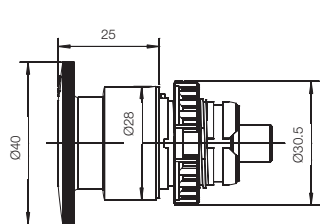

BEG
BCT

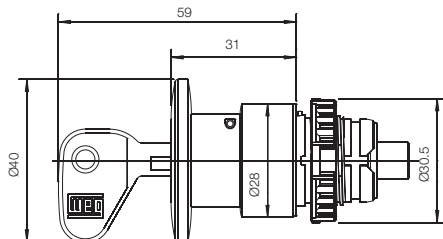

BCY

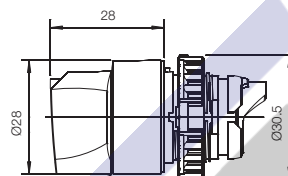

CK

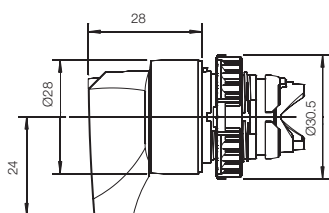

CA

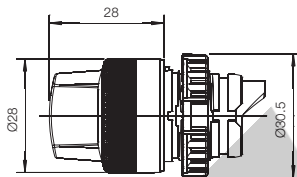

CKI

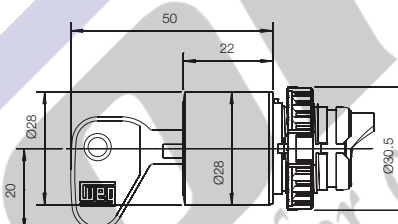

CY

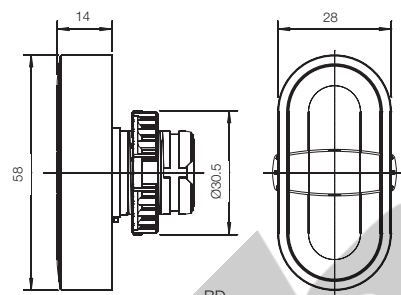

BD

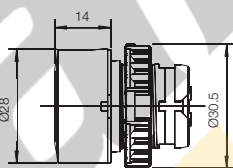

BF

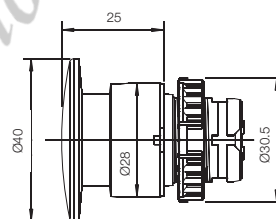

BC
BCI

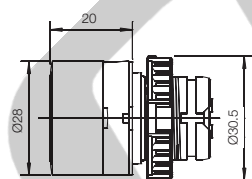

BFI
BGA

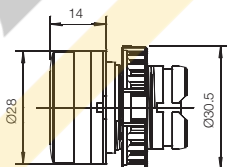

SD

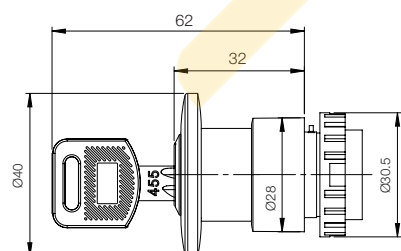

BCW

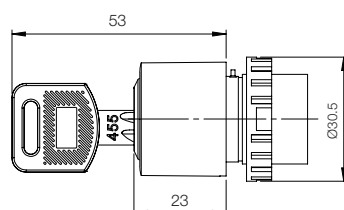

CW

Dimensions (mm)

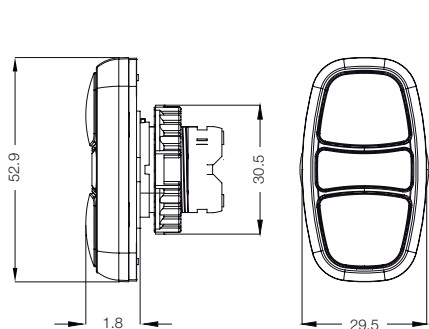

CSW2-BDF

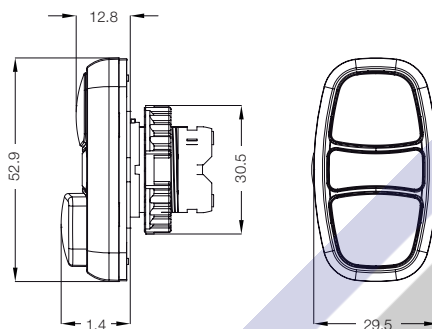

CSW2-BDS

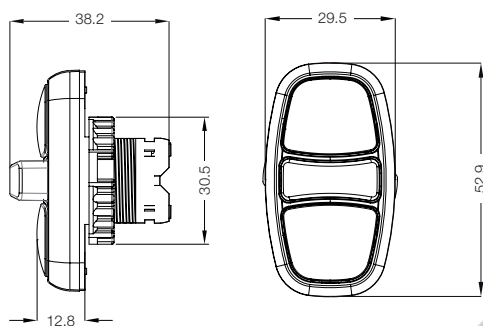

CSW2-BTF

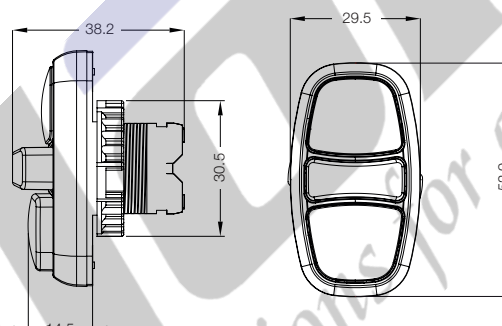

CSW2-BTS

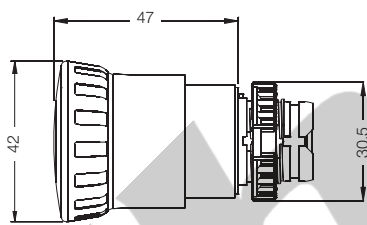

BESG

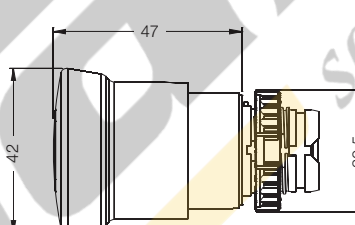

BESP

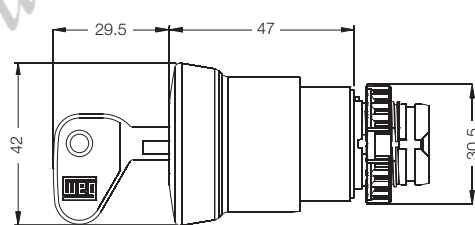

BESY

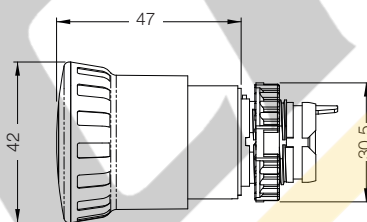

BESGM

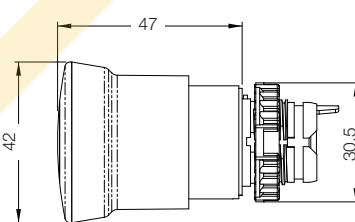

BESPM

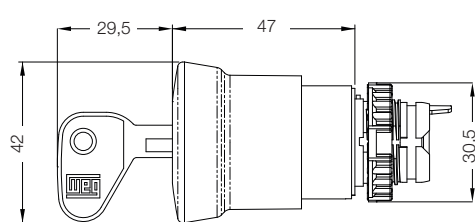

BESYM

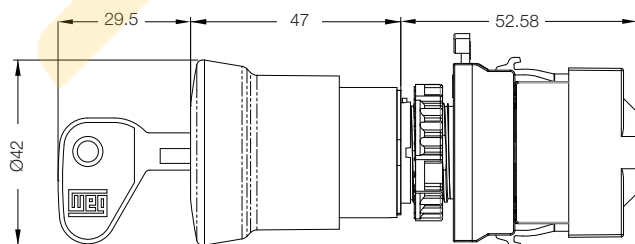

BES_M + BC10F/BC01F Contact blocks + CBCSW Tie

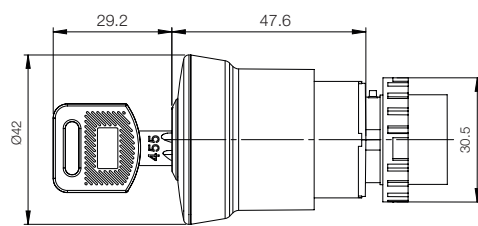

BESW / BESWM

Dimensions (mm)

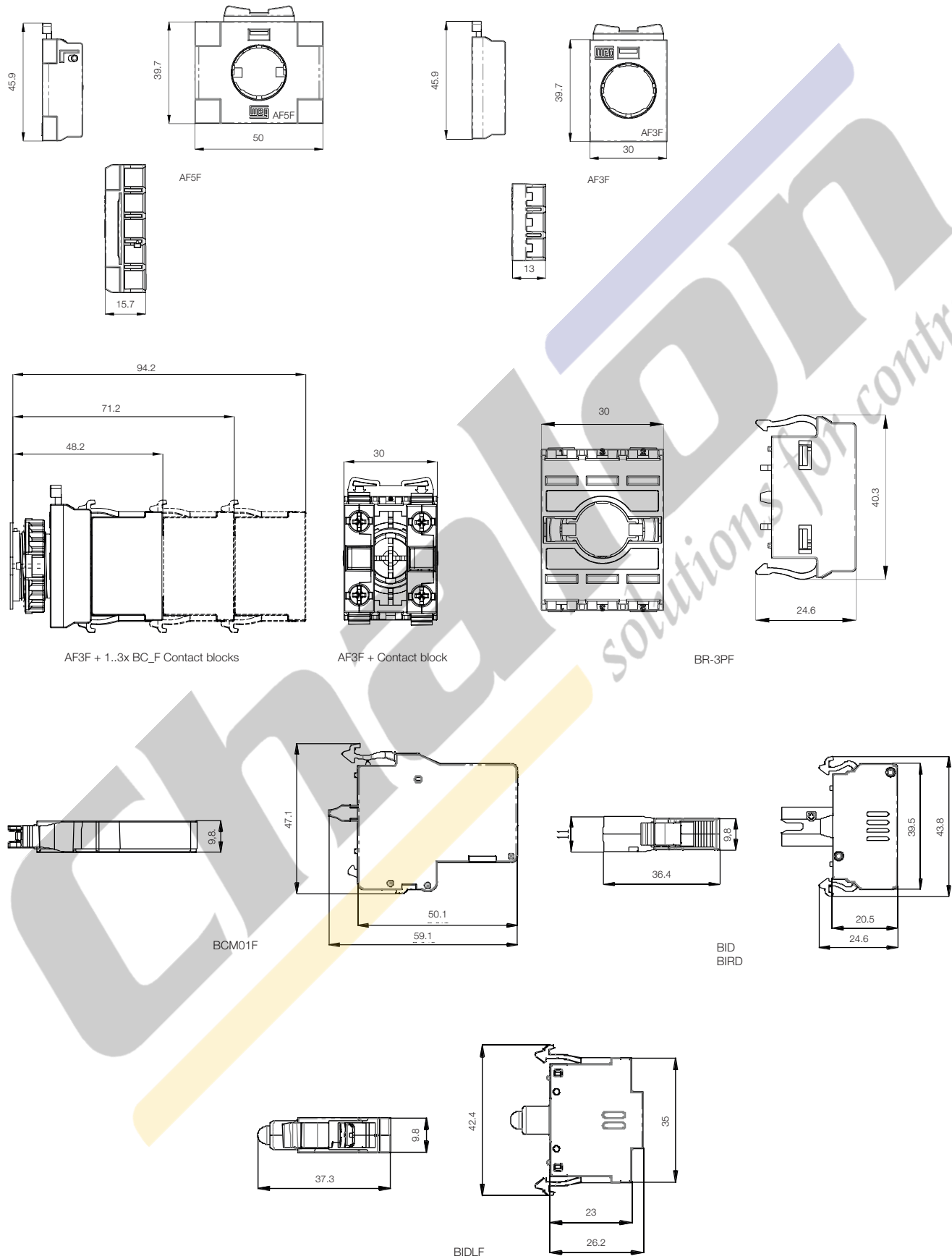

Dimensions (mm)

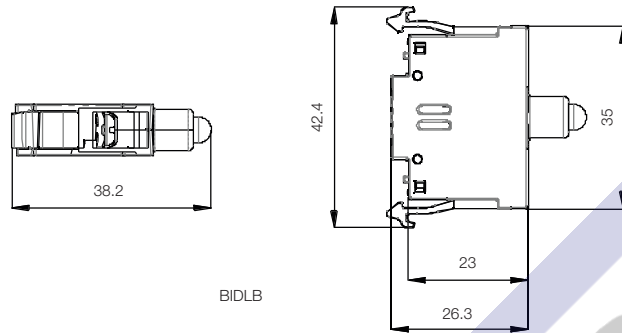

BIDL B

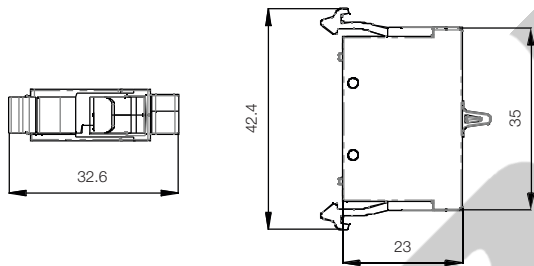

BC10B
BC01B

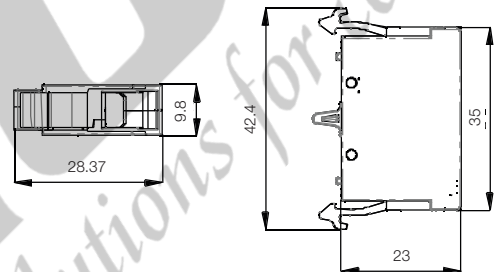

BC10F
BC01F

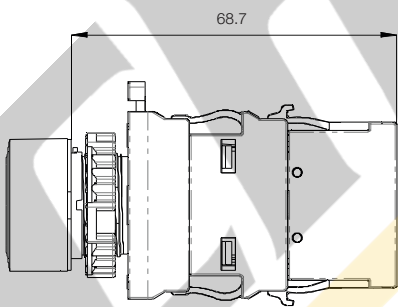

AF3F + BR - 3PF + BIDLF + BCA10F

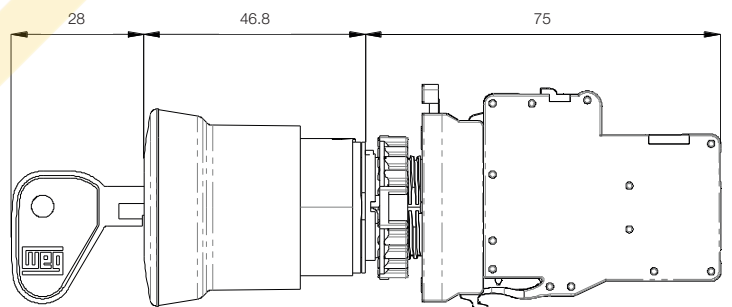

BESY + BCM01 - CSW

Dimensions (mm)

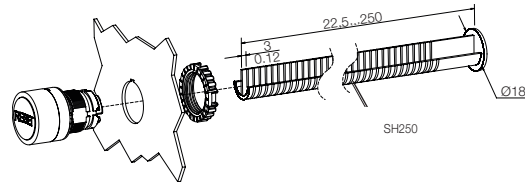

CSW-BHF437

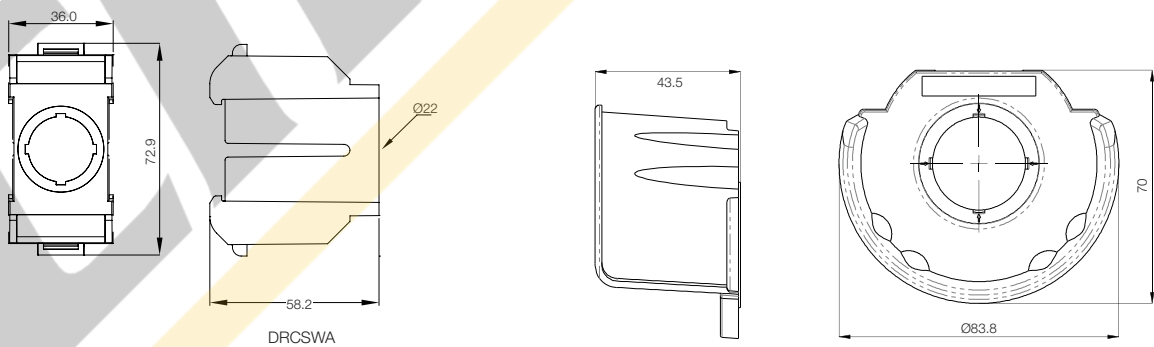
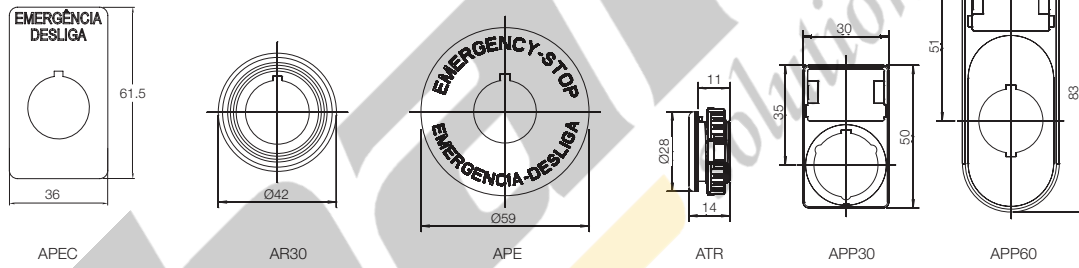
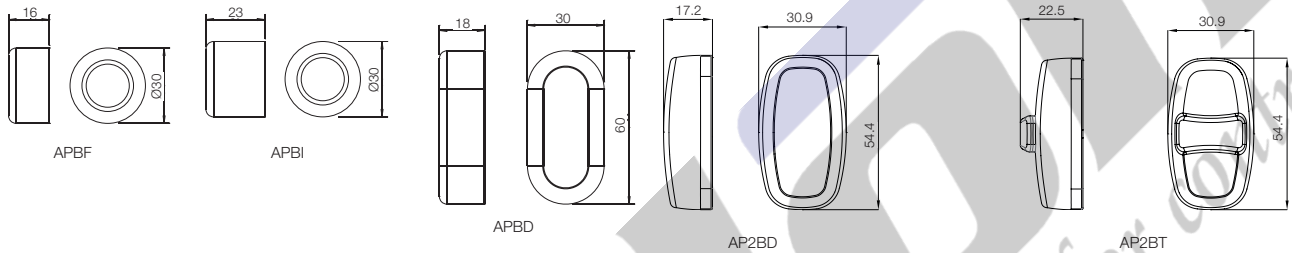

Dimensions (mm)

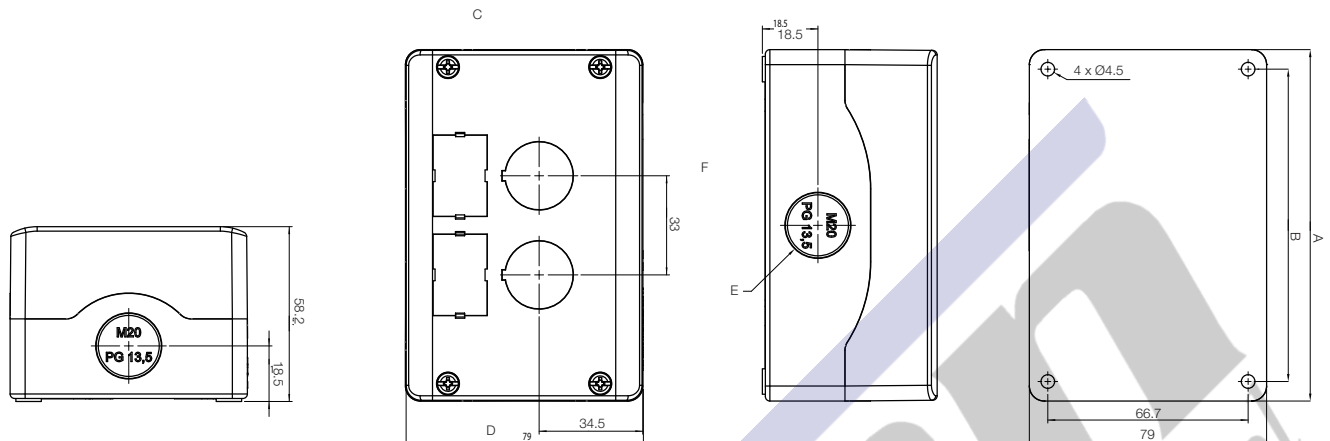

PBW / PBWL Empty Control Station

Number of holes	A	B	Cable gland entry			
			C (lower)	D (upper)	E (side)	F (base)
1	74	66.7	1x ØM20/PG13.5	1x ØM20/PG13.5	1x ØM20/PG13.5	2x ØM16
2	117	104	1x ØM20/PG13.5	1x ØM20/PG13.5	1x ØM20/PG13.5	2x ØM16
3	150	137	1x ØM20/PG13.5	1x ØM20/PG13.5	2x ØM20/PG13.5	2x ØM16
4	183	170	1x ØM20/PG13.5	1x ØM20/PG13.5	2x ØM20/PG13.5	2x ØM16
6	249	236	1x ØM20/PG13.5	1x ØM20/PG13.5	2x ØM20/PG13.5	2x ØM16

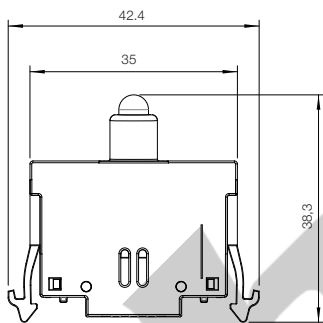

BIDLB - CSW

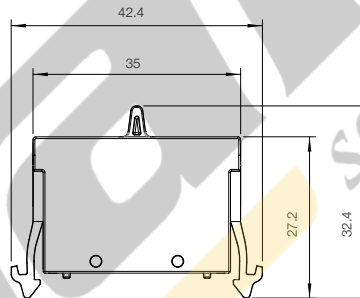

BC**B - CSW

Entry for Thread

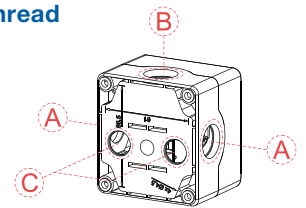

	A	B	C
PBW-1 PBW-1Y PBWL-1 PBWL-1Y	2 x M20 PG13.5 1/2"	1 x M20 PG13.5 1/2"	2 x M16 "PG9"
PBW-2 PBWL-2		2 x M20 PG13.5 1/2"	
PBW-3 PBWL-3		2 x M20 PG13.5 1/2"	
PBW-4 PBWL-4		2 x M20 PG13.5 1/2"	
PBW-6 PBWL-6		2 x M20 PG13.5 1/2"	

Installation Distances (mm)

AF3F 3-Position Flange

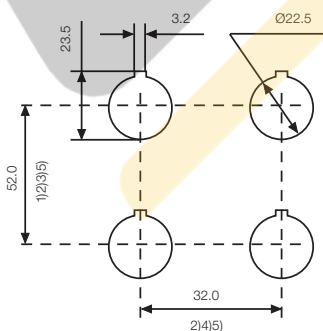

AF5F 5-Position Flange

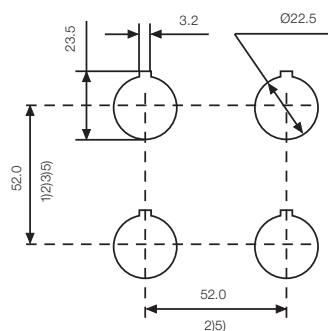

PBW/PBWL Control Stations

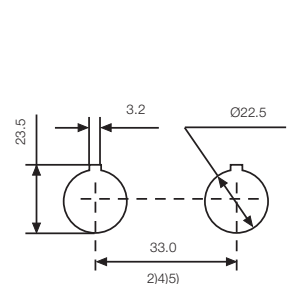

- Notes: 1) 60.0 - BD
2) 100.0 - BESG/BESP/BESY/GBES
3) 85.0
4) 35.0 - APPT60
5) 60.0 - APE

Global presence is essential, as much as understanding your needs.

Global Presence

With more than 30,000 employees worldwide, WEG is one of the largest electric motors, electronic equipments and systems manufacturers. We are constantly expanding our portfolio of products and services with expertise and market knowledge. We create integrated and customized solutions ranging from innovative products to complete after-sales service.

WEG's know-how guarantees our **CSW Line - Push Buttons and Pilot Lights** is the right choice for your application and business, assuring safety, efficiency and reliability.



Availability is to have a global support network



Partnership is to create solutions that suit your needs



Competitive edge is to unite technology and innovation

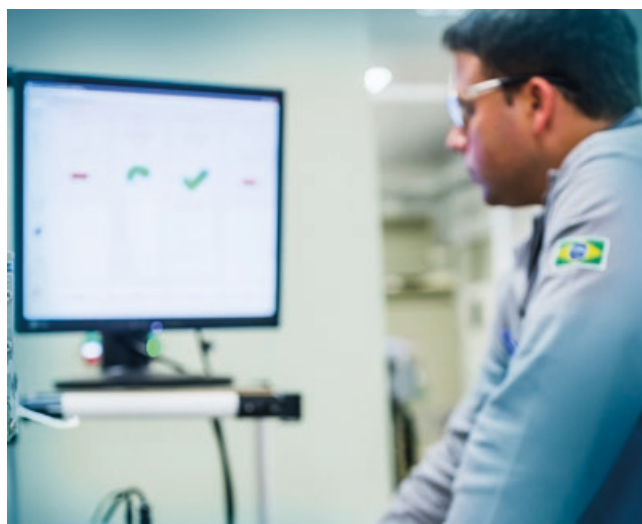

Know More

High performance and reliable products to improve your production process.



Excellence is to provide a whole solution in industrial automation that improves our customers productivity.

Visit: www.weg.net

youtube.com/wegvideos

Know the operations
WEG worldwide



www.weg.net



AUTOMATION

 +55 47 3276.4000

 automacao@weg.net

 Jaraguá do Sul - SC - Brazil

Cod: 50057066 | Rev: 07 | Date (m/y): 07/2022.

The values shown are subject to change without prior notice.
The information contained is reference values.